

Radio Topics

20 Cents



mpson
#

January -
1923

MANHATTAN

ELECTRICAL SUPPLY CO., INC.

MAKERS OF THE FAMOUS



MANHATTAN
RADIO HEAD SET

OLDEST AND LARGEST

DISTRIBUTORS OF

Radio  Corporation
of America



The Grebe "RO R" radio frequency amplifier will work with any good set and get those distant stations

KENNEDY EQUIPMENT

114 SO. WELLS ST., CHICAGO

NEW YORK

ST. LOUIS

SAN FRANCISCO

KENNEDY EQUIPMENT

The standard by which to judge Radio Equipment

SO CAREFUL has been the manufacture of Kennedy Equipment since its inception, that radio enthusiasts everywhere proclaim it the standard by which to measure all radio receiving apparatus.

KENNEDY

Short-wave Regenerative Receiver Type 281



Kennedy Regenerative Receiver, Type 281, with two stage amplifier, Type 521

is a sturdy example of the quality which has made the name Kennedy synonymous with good radio equipment everywhere. Type 281 possesses selectivity and efficiency to a high degree, these features being insured by the correct use of inductively coupled circuits.

KENNEDY RADIO EQUIPMENT
is sold by good dealers everywhere

*All Kennedy Regenerative Receivers are licensed
under Armstrong U. S. Patent No. 1,113,149*

WRITE FOR LATEST BULLETIN C-3

Address our nearest office

THE COLIN B. KENNEDY COMPANY
INCORPORATED

Rialto Bldg.
SAN FRANCISCO

U. S. A.

6400 Plymouth Ave.
SAINT LOUIS

“The wise man looks into space,
and knows there is no limit to dimension.”

said **Chuang Tzu**.

The wise Radioist bridges the greatest
distances with a

Grebe Receiver.

Doctor Mu.



A LONG RECORD of unequalled
performance has won for the
Grebe Receiver the unqualified en-
dorsement of all good dealers.

“Musings of Doctor Mu” — the
story of the development of the Per-
fect Receiver, free upon request.

GREBE RADIO

A. H. GREBE & CO.
INCORPORATED
RICHMOND HILL, N. Y.



Licensed under
Armstrong U. S.
Pat. No. 1113149



RADIO TOPICS

The National Radio Monthly

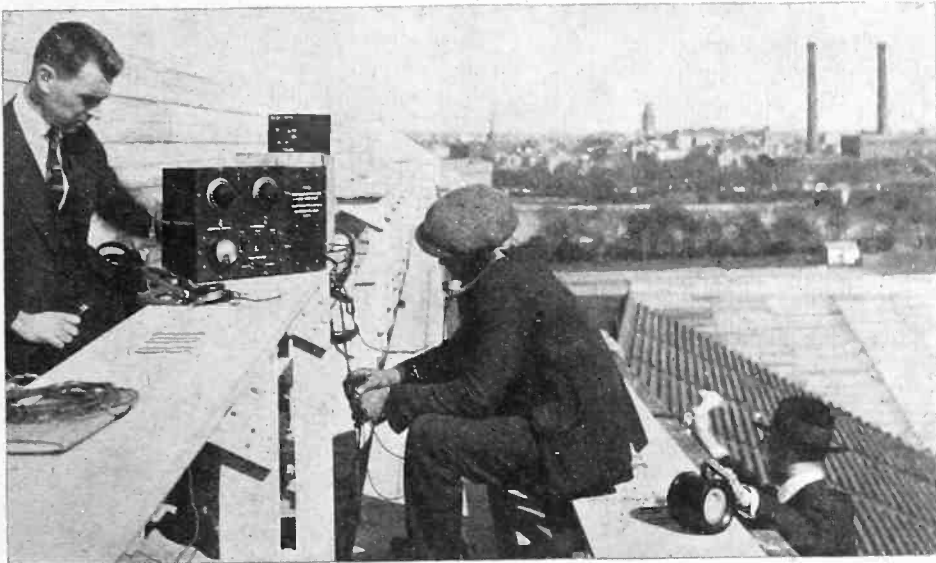

Radio brings the football games right to home.

CONTENTS FOR JANUARY

1923

Cover Design	<i>By W. Simpson</i>	
This Is a Radio Christmas.....	<i>Frontispiece</i>	
		Page
Radio Test on Moving Train Is Success.....		7
Radio Receiving Equipment.....	<i>By Frank Conrad</i>	9
Why Tickler Coils Are Inefficient Long Undamped Waves.....		14
Modern Marine Radio.....	<i>By George R. Cole</i>	15
A Short-Wave Regenerative Receiver.....	<i>Institute Report</i>	17
Radio Direction Finder and Its Application.....		18
Elementary Electrical Principles.....	<i>By H. M. Anthony</i>	23
Radio Shopping Service.....		25
How Radio Increased Good Will for Nine Concerns.....		26
Dept. of Radio Engineering—The Test and Standardization of Condensers— Report of U. S. B. of S.....		28
Recent Radio Patents.....		30
Editorials of the Day.....		32
Correspondence with the Institute.....		33
By Radio		50

PUBLISHED MONTHLY BY RADIO TOPICS

Entered as a second-class matter at the Postoffice at Oak Park, Ill., February 25, 1922,
under the Act of Congress of March 3, 1879
Business and Editorial Office at 1112 North Blvd., Oak Park, Ill.
Chicago Phone Austin 9300

Chicago Office: 4533 N. Sawyer Ave. New York Office: 240 Broadway
Copyright 1922 by Radio Topics
N. C. BOS, Pres. B. W. STOLTE, Vice-Pres. J. J. NOVAK, Treas. N. E. WUNDERLICH, Secy.



Amid health and wealth; in poverty, loneliness, joy and grief; at the side of the sick, the cripple, the shut-in; at bedside and fireside; in the drawing room, the attic, the barn; in city, suburb and crowded slum; in camp and mine and farm; mountain top and darkened valley; in the snows of the north and amid the flowers of the south—there radio brings cheer.

You who know what radio means, can enter into the true spirit of the holiday season by sharing the broadcast programmes with your friends, for

'This is a Radio Christmas'

Illustration from Judge, Dec. 22

Radio Topics

An Illustrated Monthly Devoted to Radio

Volume II

JANUARY, 1923

Number 12

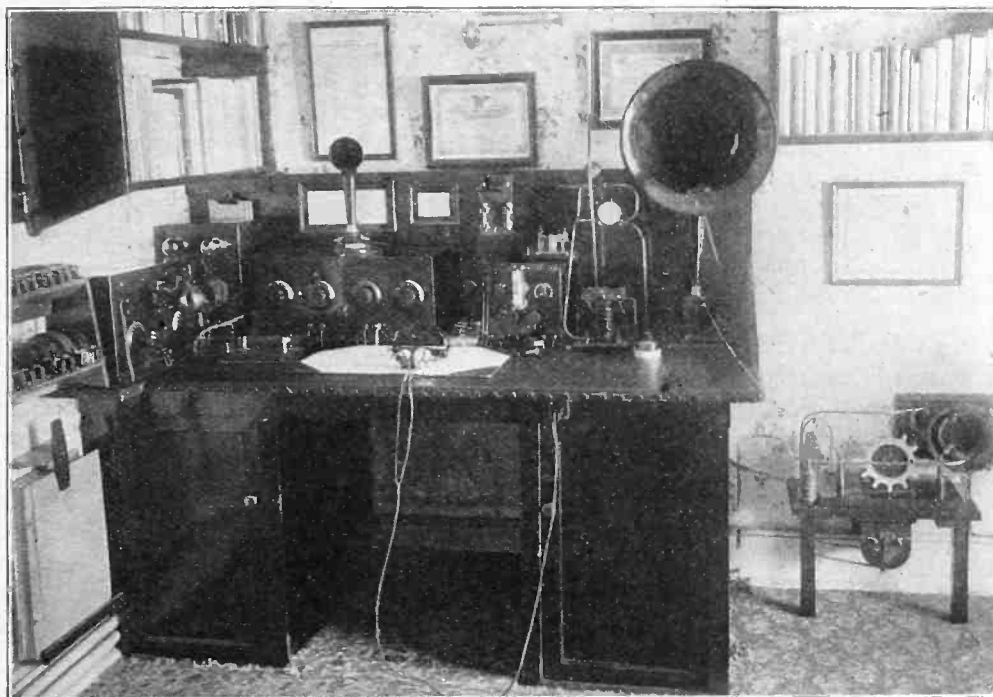

Radio equipment on Palace Express which picked up KSD broadcasting as train sped to Chicago.

Radio Test on Moving C. & A. Train is Success

The radio test by the Chicago & Alton Railroad between St. Louis and Chicago, by arrangement with the Post-Dispatch KSD station, met the most sanguine expectations of officials of the railroad and passengers on the Palace Express, who heard voice and music on the swiftly moving train from KSD and Atlanta until 1:30 a. m. October 25.

The test was the more remarkable because of the fact that the receiving set was operated without the use of aerial or antenna, the electric wiring of the interior of the steel observation coach being utilized to intercept and transmit waves.

EXPERIMENT CONVINCING.

"The experiment was convincing in all its aspects," said S. U.

Rhymer, signal engineer and superintendent of telegraph of the railroad, who was assigned to watch the tests and report his observations to the management.

"I believe, from what I have seen, that the day is not far distant when a train dispatcher will sit at a division point on a railroad in constant personal communication with crews of the trains in operation."

Three other officials of the railroad and a representative of the Denver & Rio Grande, who witnessed the tests, were similarly impressed with the practicability of radio communication with moving trains and all made seemingly extravagant prophecies of train operation by radiophone.

SEQUENCE OF CLEAR SIGNALS.

A sequence of clear signals

were received on the moving train from the moment it departed from Union Station at 9 o'clock, uninterrupted except for occasional brief periods of adjustment to meet topographical conditions, such as running thru cuts and over bridges, and when K S D was tuned out about 12:30 a. m. at Springfield, ninety-one miles from St. Louis, Atlanta, Ga., was picked up and passengers who usually retire comparatively early, occupied every seat in the observation car and were entertained by the scientific novelty until the set was cut out at 1:30 o'clock.

The set employed to receive the signals was a two-step regenerative set with two-step amplifier and loud speaker, in charge of W. E. Woods of the Benwood Company, who said he had wired it so

as to be highly selective, to eliminate interference by movement of the train and to avert confusion with signals of stations other than K S D.

The set was simply carried into the observation car and placed on a table. The only connections made to the car were a ground wire attached to a water pipe and plugging into an ordinary electric light socket. The latter connection was to serve as an aerial.

FIRST SIGNALS IN STATION

The first signals from K S D were received in the car in Union Station at 8:30 o'clock, distinct and clear, which Wood said was remarkable in that no interference was encountered because of the steel structure of the station and of the coach itself.

A tuning operation of about five minutes' duration was necessary when the train started to move, and from 9:05 to 9:30 the voice and orchestra music grew gradu-

ally louder and more perfect on a fixed adjustment.

The first trouble was encountered at 9:50 o'clock, presumably from ground interference caused by the car wheels when running about fifty miles an hour, but this was adjusted for the time being, and signals remained distinct and clear thru the loud speaker at the far end of the coach above the noise of the train.

PHONES USED TO LISTEN IN.

The second K S D jazz orchestra concert was successfully tuned in thru the loud speaker at 11:15 o'clock, but had become so faint fifteen minutes later that the loud speaker was cut out and passengers and railroad officials listened in thru phones.

All the bulletins that were read between 9:30 and 11 o'clock were distinctly heard, the modulation being excellent, and while orchestra music was inaudible thru the loud speaker just before reaching

Springfield telegraph signals of amateurs thruout the South and West were tuned and reproduced thru the horn. Among the amateurs who were distinctly heard were 5 ABH at Oklohoma City, 4 AAM of Atlanta and 9 CIE at Ellendale, N. D., working with an amateur at Dallas, Tex., who could be heard in response.

The electric light generator on the car caused most of the interference as the distance from St. Louis lengthened, due to the fact that the leads from the generator went direct to the set. Had the interior of the car been wired for radio when the coach was built, Wood said, it would have been possible to get K S D clear on the loud speaker at all times.

At a point about twenty-five miles out of St. Louis the plug was removed from the light socket, thus disconnecting the aerial, and signals picked up by the receiving set itself were audible and clear thru the loud speaker



AN EFFICIENT RADIO DEALER

Who makes deliveries with a radio equipped car. His store also has a transmitter, which furnishes the music when the car is traveling around.

Radio Receiving Equipment

By Frank Conrad

(Assistant Chief Engineer, Westinghouse Electrical and Manufacturing Company, E. Pittsburgh, Pennsylvania)

THIS paper is intended to discuss questions of design of those types of receiving apparatus which are adapted for reception over a limited range of wave length, and which depend for their operation on such manipulation as can be successfully carried out by persons entirely unfamiliar with the technique of radio apparatus. Their principal field of application is the reception of broadcast radio telephone signals.

Among the many requirements which an ideal receiver of this class should fulfill are that:

(1) It should tune in the wave length desired with only simple adjustments, which should not interact on each other. With a signal of normal audibility from a desired station, the signal strength from another equal or possibly more powerful station, separated by ten thousand cycles, should be below audibility.

(2) Its sensitivity should be such that its range will be limited by static interferences, fading, and so on, rather than by actual lack of response. Any local sources of power necessary for its operation should require infrequent attention.

The curve in figure 1 shows the relation of admittance to wave length in a simple oscillating circuit which has the constants of the antenna ordinarily used and which is tuned to a definite wave length by the addition of a variable inductance.

An examination of this curve shows that, although the maximum signal is obtained for the wave length to which the circuit is tuned, appreciable response is given to wave lengths differing considerably from those for which it is in resonance.

In order to obtain the desired selectivity, it is necessary considerably to increase the time constant of this circuit. This result can be accomplished in one or both of two ways: namely, by increasing the inductance element with a corresponding reduction, of capacity or by decreasing the effective resistance by regeneration.

The curve in Figure 2 shows the effect of placing an additional capacity of 25-micro-microfarads in series with the circuit with a corresponding increase in inductance to bring the circuit in resonance with the same wave length as under the first condition.

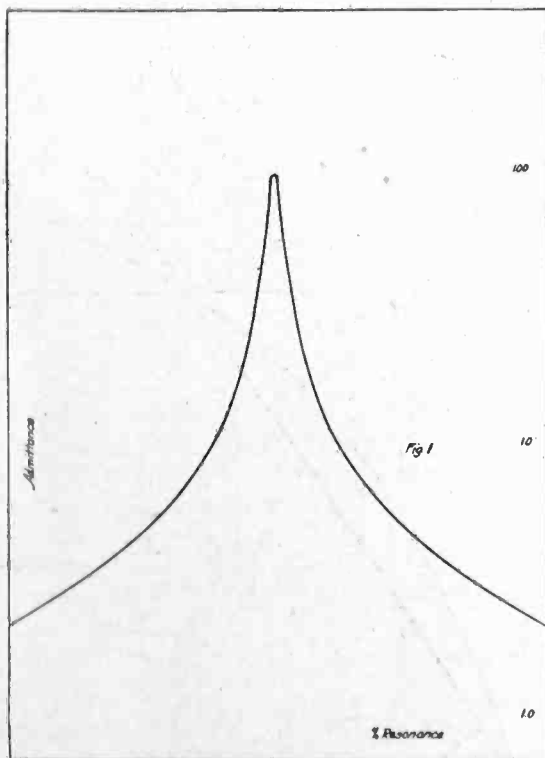

FIGURE 1.

The first-mentioned requirement, which may be termed selectivity, is more or less fulfilled by giving the receiver a characteristic in which its impedance to the desired band of wave length is very low in comparison with its impedance to the wave length above and below this band.

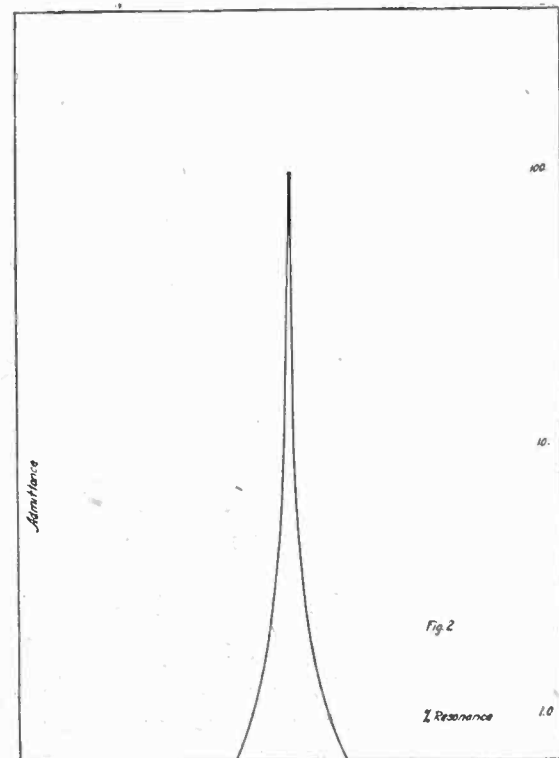

FIGURE 2.

It will be noted that the selectivity is very considerably improved.

In the case of a vacuum tube detector, which is nominally a voltage-operated device, the large inductance implies a correspondingly large voltage available for operation of the detector, with the resultant increase in signal strength. In the case of the crystal detector, the maximum signal

strength is obtained when the effective resistance due to the detector is equal to that of the balance of the antenna circuit. It therefore should be connected across such part of the inductance as will give the best compromise between selectivity and sensitivity.

The use of the regenerative vacuum tube offers the further possibility of increase of selectivity with the additional advantage of a very marked increase in sensitivity.

The curve, Figure 3, shows the relation of admittance to wave length of the same circuit as that for Curve 2, with the exception that the resistance element is assumed to be one percent of that in Figure 2. This is an amount of regeneration which can readily be obtained. The ordinates of this curve are drawn to a scale one hundred times that of Figure 1 and 2, and it might be assumed that the signal strength would be one hundred times that which would be obtained from the circuit of Figure 2. This condition does not necessarily follow, owing to the fact that there is a definite limit to the component of antenna current which is proportional to the incoming signal.

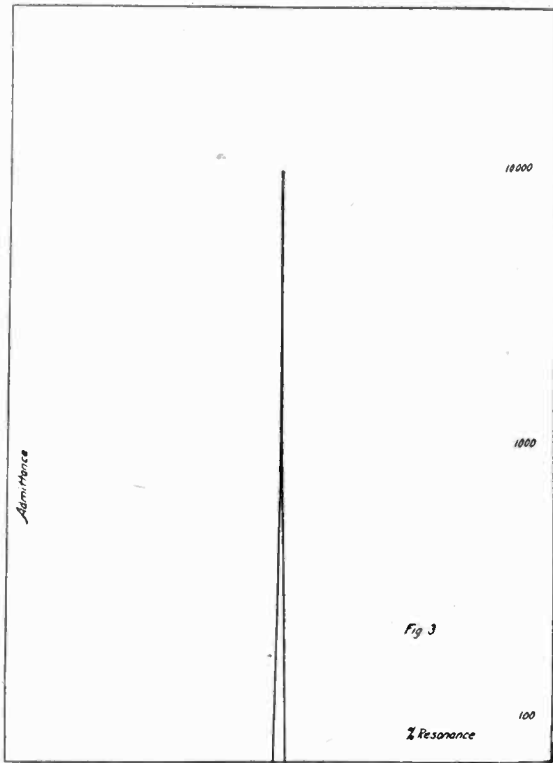

FIGURE 3

This condition may be illustrated by the diagram, Figure 4. In this diagram, $O E$ represents the incoming signal affecting the receiving antenna. Should the impedance of the receiving antenna circuit be indefinite, the voltage induced in this circuit will be in the phase $O C$. For finite values of resistance impedance in this circuit, the current will be bounded by the circle $O B A$. Thus, for a given value of resistance impedance, the current will be represented by the line $O B$. The field surrounding the antenna due to this current will have the same phase and relative length, and the total effective field will be the sum of $O E$ and $O B$, or $O D$. For zero resistance the current will have the phase and relative length $O A$, with a zero resultant field. Further consideration will show that this ultimate received antenna current is independent of the height of the antenna, provided all

sections of its length are affected by the same field intensity, it being dependent only upon the field per unit length.

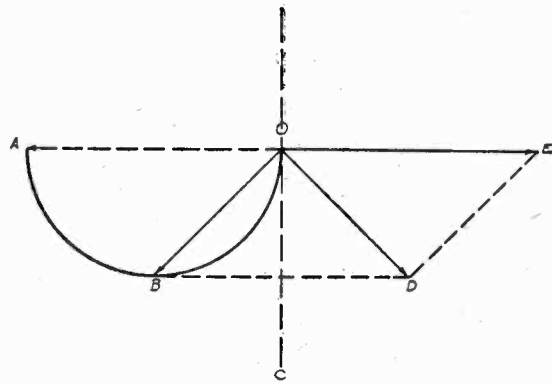

FIGURE 4

The antenna therefore may be considered as a constant voltage generator, having a definite internal impedance, which is proportional to antenna height. This generator supplies a load circuit having the constants of the oscillating circuit.

In the case of a regenerative system in which the regeneration is carried out to such an extent as to produce oscillations, the current due to the incoming signal will be superimposed on the local current, and have a value dependent entirely upon the effective resistance but independent of any local oscillating current.

Figure 5 shows the conditions determining the resistance of the antenna circuit under the oscillating condition. In this curve line G shows the relation of voltage impressed on grid terminals to the oscillating component of plate circuit. Curve P shows the oscillating component of plate circuit set up by this impressed grid voltage. From this curve it will be seen that,

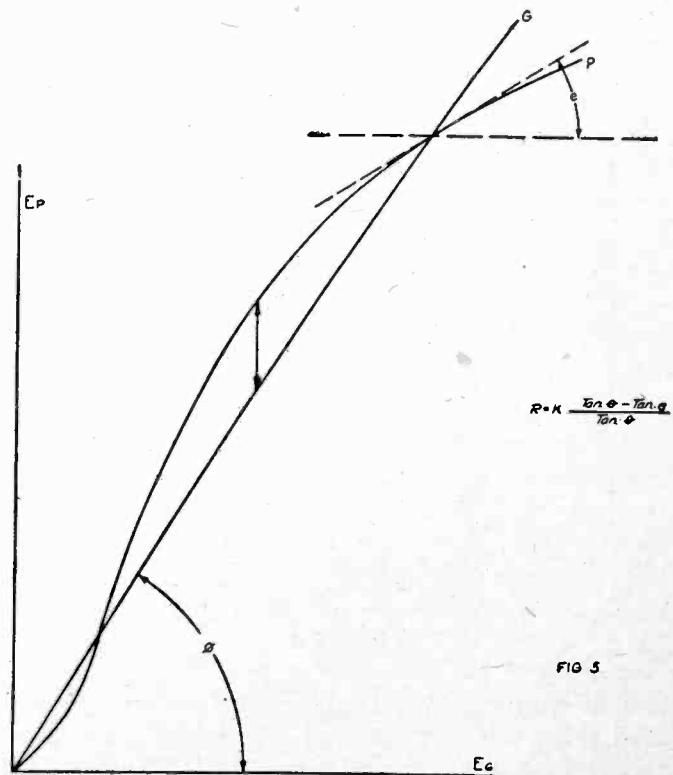

FIGURE 5

once the oscillations are started, they will increase to a point where the curve P intersects the line G . The effective resistance of the antenna circuit is determined by the relation of the angle of this intersection

to the angle of G with the base. In actual practice it is possible to reduce the angle of intersection at this point to such a value that the antenna current due to incoming signal will closely approach the ultimate value. Any possible increase of the sensitivity is therefore limited to an increase of the inductance across which the detecting circuit is connected. The extent to which this increase can be carried out is largely a matter of design.

The limitation of sensitivity due to ultimate antenna current also imposes an apparent reduction in selectivity and is a feature which usually is not considered in the discussion of the oscillating circuit.

Referring to the curves, Figures 2 and 3, these show the characteristic of simple circuits made up of capacity, inductance and resistance. In the case of an actual antenna circuit, it has been shown that there is, in addition, a limiting impedance which is proportional to the height. In the consideration of the sharpness of tuning of the antenna circuit, it is necessary to consider this limiting impedance in addition to the actual impedance of the oscillating circuit. Therefore, the actual increase of sharpness of tuning which can be obtained by regeneration is largely determined by this limiting impedance, or, in other words, by the antenna height.

In Figure 6 are shown two curves taken with similar receiving sets, but on antennae of different heights. The left-hand curve is from a single-wire, inverted-L antenna, having a height of 35 feet (10.6 m.) above ground, and a length of horizontal portion of 75 feet (23 m.). The right-hand curve was taken from an antenna having a height above ground of 15 feet (4.6 m.), the length of horizontal portion being the same. The same receiver was used in each case.

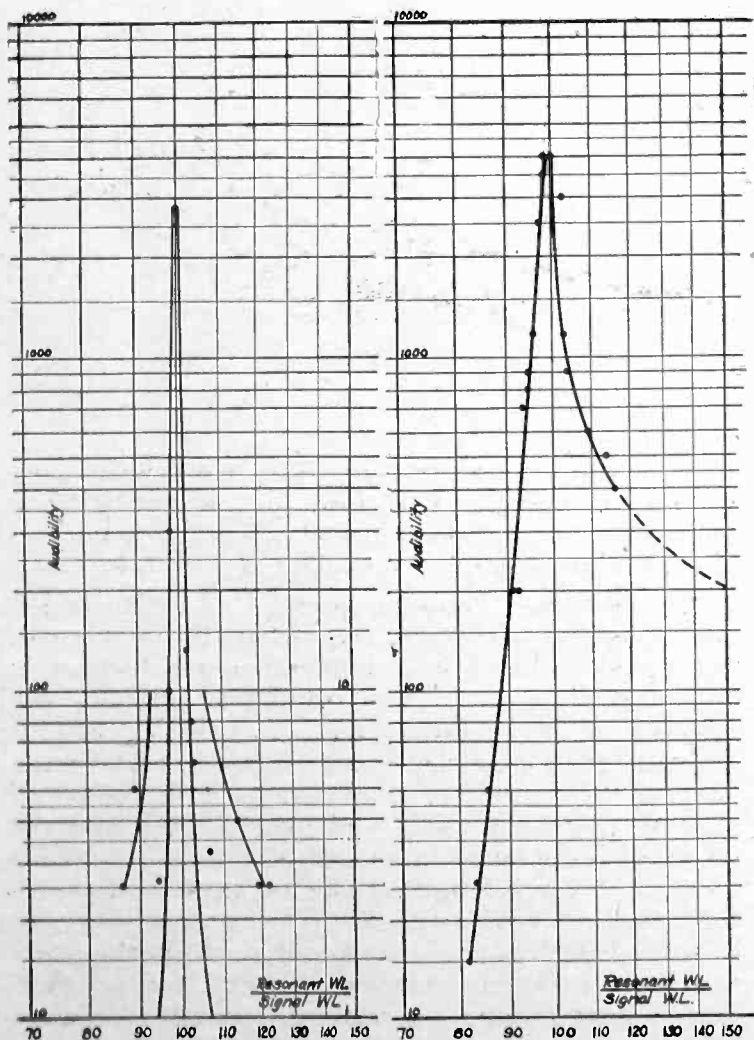

FIGURE 6

These two curves show the very great increase of selectivity to be obtained by the use of low antenna. In fact, the increase is considerably greater than would be expected from consideration of the comparative heights of the two antennas. It is probably accounted for by the condition that the effective height of the lower antenna is a considerably smaller percentage of its actual height than in the case of the higher antenna, owing to the indefinite height of the ground connection which was made to the hot water heating system, thus giving an effect equivalent to raising the height off the actual ground.

Due to the absorption by objects on or near the ground, it is usually impossible to realize completely the condition of equal signal strength with low as with high antenna, and of course the possibilities in this direction depend on the surroundings of the antenna in question.

Under conditions in which the reduction of signal strength with height is due, as is often the case in thickly built-up districts, to the appreciable absorption near the ground, it is possible to improve the selectivity of the antenna by the use of a coupled secondary circuit in the receiving set. If another resonance circuit of the same constants were connected to the output circuit of a vacuum tube amplifier connected to a resonance circuit having the constants corresponding to that of Figure 2, the characteristic of this double circuit would be proportional to the product of the characteristic curves, which, it is evident, would give a very greatly increased selectivity.

This arrangement constitutes the ideal method of improving the selectivity of a receiver. If, in place of the relay coupling between the oscillating circuits, a direct coupling were used, the relation of the secondary to primary would, in a sense, be a duplicate of that existing between primary and the transmitter, with the equivalent antenna height of secondary corresponding to the looseness of coupling, thus permitting the possibility of a receiver connected to a high antenna and with the selectivity of a low one. However, the extent to which this can be carried out is limited by the fact that, as the apparent secondary antenna height is reduced by reduction of coupling, the reduction of primary resistance by regeneration is also reduced, with a corresponding limitation of ultimate secondary signal current and its attendant reduction of selectivity.

Owing to the difficulty of carrying out the necessary interacting adjustments, the use of a coupled circuit receiver is justified only under those particular conditions in which it is not possible to take advantage of the selectivity of the low antenna.

A further possibility towards the solution of the receiver problem for congested districts is the use of a closed coil or loop in place of an open antenna. The loop receiver will have the advantage that, similar to the short antenna, it embraces a limited field area, and at the same time can usually be placed sufficiently above ground level to be in a somewhat denser field than would be the case with a corresponding short, open antenna. The limiting impedance of the loop is comparatively low, but as the induced signal voltages are also low, it is necessary that a regenerative system be used in order to obtain the benefit of selectivity. It, of course, has certain possibilities of eliminating interference, due to its directional properties. In general, the loop receiver under its best conditions, will give results which are practi-

cally identical with those obtained from a receiver connected to a properly proportioned, open antenna, barring, of course, the possibility that the relative position of the interfering station may be such as to permit of advantage being taken of the directional effect. It has the advantage of convenience of installation and of not being restricted to location as regards height where the field density may be low. However, the first cost and maintenance expense of such a receiver are far greater than those of equivalent regenerative set on an open antenna, and for these reasons, cannot, at the present time, be considered as a real competitor of the open antenna receiver.

The foregoing conclusions in regard to the conditions effecting selectivity are based on the premises that the receiver is used for the reception of modulated wave signals and that the interferences to be dealt with are those set up by similar transmitters.

In the case of interference resulting from atmospherics, or static, the particular precautions which would minimize interference from other transmitters would have insignificant effect, and at the present time there is no practical scheme which gives any appreciable reduction of interference from static.

In the case of interference from damped wave transmitters, the effects will lie between the conditions of a modulated continuous wave signal and static, the similars to one or the other being determined by the decrement of the interfering signal.

In the case of the usual amateur spark transmitters, which is the one most likely to set up the interference, the conditions will be not far removed from those governing the effects of static, owing to the usual high decrement of these transmitters.

The solution of the problem of interference from this source should be in the direction of elimination of the spark transmitter by the substitution of continuous wave sets, rather than by any receiver development, owing to the actual great width of wave band covered by even the best type of spark transmitter.

The one serious defect of the regenerative receiver is the interference it can produce on other receivers due to radiation when regeneration is carried to the oscillating point. The intensity of this radiation can be controlled to a certain extent by the antenna circuit constants and the constancy of regeneration of the receiving set with various wave length adjustments.

With increase of inductance element in the antenna circuit, the antenna current for a given voltage applied to a receiving tube is correspondingly reduced, with attendant reduction of interference; and, with constancy of regeneration with varying wave length adjustment, the possibility of the set producing strong oscillations during the tuning operation will be reduced. This latter feature has considerable bearing on the system of regeneration which it is advisable to employ.

The mechanism of regeneration implies a coupling between anode circuit of tube and oscillating circuit, such that any fluctuations in anode current sets up corresponding oscillations in the oscillating circuit, and of such phase relation as to reinforce the original

oscillations which had acted on the grid of the tube. This coupling may be electro-magnetic or electro-static.

In the electro-magnetic coupling a coil which is in series with the anode circuit is so disposed that its field embraces more or less of the inductance in the oscillating circuit.

With the electro-static coupling, advantage is usually taken of the capacity between grid and anode elements of the tube and its connections. When the impedance of the anode circuit is altered by a varying grid potential, corresponding potentials are induced on the grid element thru the capacity of tube and connections. When the grid is connected to a resonant circuit and the impedance in the anode circuit is principally a resistance, the phase relation of induced potential on grid thru anode is 90 degrees displaced from the original controlling potential of the grid. An inductive reactance in the anode circuit so shifts the induced potentials that it assists or adds to the potential grid controlling potential. A capacitive reactance so shifts the phase relation that the

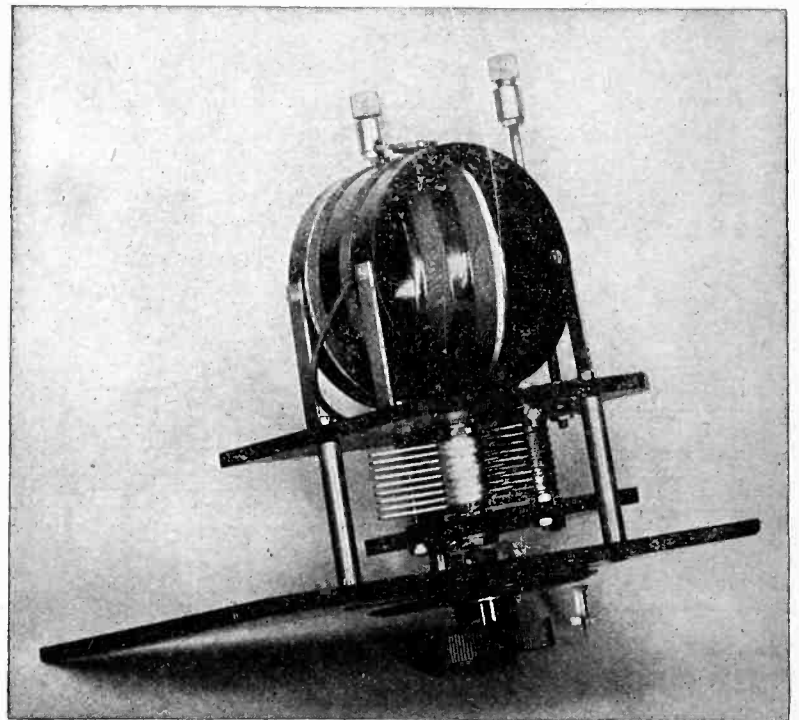

FIGURE 7

induced charge grid subtract from the original controlling potential. Therefore, by incorporating a variable inductance in the anode circuit, the amount of regeneration can be controlled at will.

The inductive coupling method of regeneration possesses the advantage that when the anode coil is coupled to the variable inductance which controls the wave length of the oscillating circuit, the amount of regeneration remains practically constant over an extended wave length band. In the case of the capacitive coupling, both the effect of capacity between anode and grid circuits and the effect of inductance in the plate circuit vary with change of wave length. The regeneration, therefore, requires readjustment with each readjustment of wave length of the set. For this reason the operation of tuning-in a signal is more complicated. The inductive coupling method, however, requires proper proportioning of the relation between coup-

ling coil and tuning inductance, while the capacitive coupling merely requires the insertion of a variable induction in the anode circuit and the necessary by-pass condensers to shunt the radio frequency fluctuations in this circuit around inter-tube transformers or telephone receivers. For this reason, this arrangement has been a great favorite with radio experimenters as well as manufacturers of receiving apparatus, who have merely assembled conventional parts in a containing case.

From the standpoint of interference produced by the receiver, therefore, the inductive coupling method is considerably superior to the capacitive coupling, owing to the fact that the coupling can be set at some value below the oscillating condition, which it will maintain throughout the whole range of wave length adjustment. The degree of regeneration which can be obtained over the whole range without oscillations occurring at any point is, of course, dependent upon the excellence of design of the set. In case of the capacitive coupling, as the

varied for adjustment of resonant wave length, as by this means the proper coupling between the resonant circuit inductance and the feed-back coupling coil for constant regeneration at various wave lengths can be obtained.

In Figure 7 is shown the interior of a typical regenerative receiver, using inductive coupling for regeneration, and simultaneous variation of both inductance and capacity for wave length adjustment. This receiver covers a comparatively long range of wave length with one continuous adjustment, and in order to compensate for the comparatively small angle of adjusting knob which will carry a heterodyne note thru the audibility range, it is fitted with a so-called "vernier" condenser, consisting of a small single plate variable condenser in parallel with the main tuning condenser. The total range of this condenser is made equivalent in wave length change to a few divisions of the main tuning dial. This receiver is normally intended to be used as a single circuit set. However, for conditions surrounding the antenna under which it is not possible to realize the necessary selectivity, it can be used as a tuned circuit set by using a separate primary tuner, as shown in Figure 8, the secondary tuner being merely short circuited on itself.

When the boxes containing the two elements are placed side by side, they give about the proper coupling for usual operating conditions. As the coupling is between the variable inductances, these can be proportioned so that they maintain the proper coupling value over the whole range.

In Figure 9 is shown a single-circuit regenerative receiver in which the inductance element alone is varied for the purposes of tuning, a fixed capacity being used in series with the antenna circuit for the purpose of increasing selectivity. However, this fixed capacity is made in two steps, thus permitting two separate wave length ranges. The regenerative coupling coil and the main tuning inductance are so inter-related as to give practically constant regeneration over the whole range of possible wave length adjustment, when the set is connected to the average antenna.

The foregoing remarks mainly cover questions of design affecting the tuning elements of the receiver, and on the general assumption that a three-element vacuum tube receiving system of the requisite sensitivity is employed.

The problems which may be presented for future development will be influenced largely by the condition imposed on the operation of the transmitting stations. With the transmitters grouped in one band of wave length, the possibilities of improvement are very remote. With the separation of transmitting waves, the ease of solution of the interference problem increases with the extent of this separation. The logical solution would appear to be a separation which would correspond to the possibilities of available receiving apparatus, and it is probable that, as the number of transmitters continues to increase, with a corresponding reduction of wave separation, the development of receiving apparatus will keep pace with the increasing exactitude of requirements.

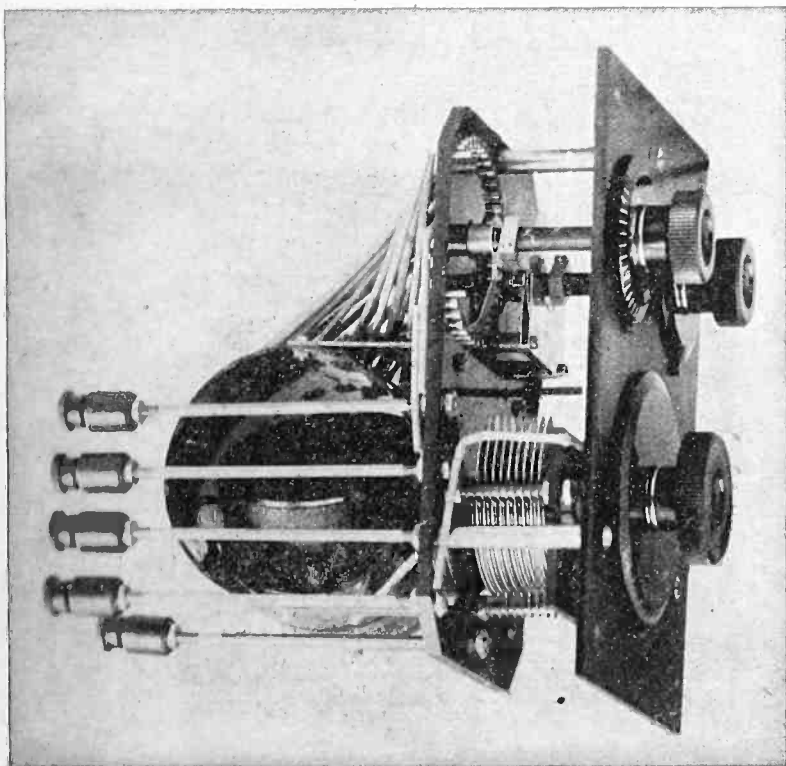

FIGURE 8

degree of regeneration increases at a very rapid rate with decrease of wave length setting, it is necessary, in order to obtain any appreciable regenerative effect, that simultaneous adjustment of anode inductance be made with adjustment of wave length.

The design of the oscillating circuit tuning elements of a receiver is largely determined by the range of wave length desired and the regenerative scheme employed, if any, the inductance or capacity elements alone may be variable, or, to obtain a greater range of wave length adjustment, they may both be variable.

When the inductive coupling for regeneration employed, it is usually desirable that at least the inductance element in the oscillating circuit be

Why Tickler Coils are Inefficient for Long Undamped Waves

Although widely used, the tickler coil method of heterodyning causes a very considerable loss of energy on wavelengths over 5,000 meters.

WHEN you are copying a station operating on 18,000 meters, you wouldn't knowingly tune your secondary circuit to 17,000 meters, or 19,000 meters—would you? But have you ever stopped to think, when you do this very thing when you use a tickler coil or other means for making the secondary circuit oscillate locally to receive undamped wave stations, that is exactly what happens.

tuned above and below the wavelength of the transmitter. A maximum amount of energy flows in the secondary when it is adjusted to 18,000 meters, but at 17,000 the wavelength for a 1,000-cycle beat note, only 55% of the available energy is being used. This is obviously a considerable loss, of special importance when the signals are weak.

That this percentage of loss decreases with the wavelength is

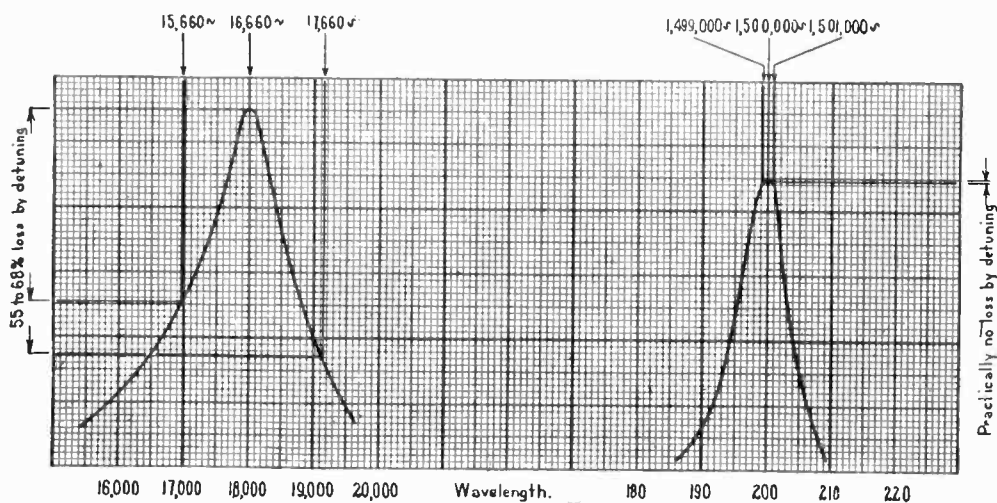

Fig. 1.—There is a considerable loss by detuning on wavelength over 500 meters. Fig. 2.—As the frequency is lowered, the loss decreases. At 200 meters it is negligible.

To make this point clear, consider the theory of heterodyne reception. A frequency is impressed upon the incoming signals, the result of which is a note in the receivers of a frequency equal to the difference in frequency between the incoming and impressed or local oscillations.

In practice, the primary circuit is closely tuned to the transmitter. The secondary is *detuned*, to give an audible frequency. So it is that the secondary circuit is not adjusted to the frequency of the received signals.

At short waves, a slight detuning in wavelength makes a large difference in frequency, so that this affect is not pronounced. Long waves, however, have a low frequency. Thus a small difference in frequency requires a considerable change in wavelength.

Consider Fig. 1. This shows the signal strength when a receiver is

shown by Fig. 2. Here the curve shows the energy in the secondary when it is turned above and below the wavelength of a 200-meter transmitter. The detuning to produce 1,000-cycle beats is less

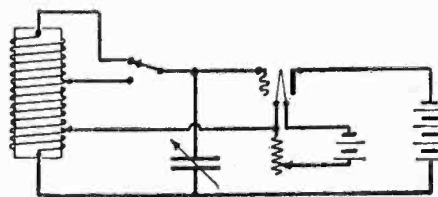

Fig. 3.—Circuit for separate oscillator using a tubular coil.

than 1 meter, and practically no energy is lost.

On wavelengths above 5,000 meters, heterodyne reception should be accomplished by means other than the use of a detuned, oscillating circuit. The simplest method is to set up a separate oscillator, coupled to a straight receiving set.

Fig. 3 shows the connections for a simple and powerful oscillator which, without any auxiliary adjustments, will oscillate at any wavelength depending only upon the sizes of the coil and condenser. For reception between 5,000 and 25,000 meters, using a 0.001 mfd. condenser, the coil should have an inductance of 125 millihenries, tapped at 50 millihenries for tuning down to 4,000 meters. A coil of this size should be wound for 11½ ins., with two banks of No. 28 single silk-covered wire on a tube 5½ ins. in diameter; 1¼ pounds of wire are required. This may sound like a tedious job, but, as a matter of fact, small wire is not hard to bank. The 50-millihenry point is 5½ ins. from the start of the coil.

Also a tap is taken off 3 ins. from the start, for connection to the filament of the audion, Fig. 3.

Another method is to use two 65-millihenry honeycomb coils for the long range. Connections are given in Fig. 4. They are set up close together, so that they act as one coil, tapped at the center.

For short-range work only a crystal detector is needed to receive undamped waves if this oscillator is used, or for long distance, an audion detector is required.

To operate the set the oscillator is set up near the receiving inductance, so that the axes of the two coils are parallel. The receiver is tuned to approximately the wavelength of the transmitter to be

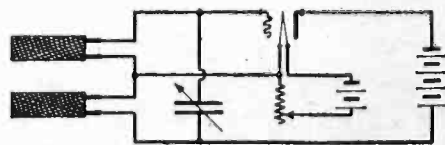

Fig. 4.—Honeycomb coils can be used in place of the tubular inductances.

copied, and, as the receiver is adjusted, the condenser of the oscillator is swung back and forth until the proper conditions for heterodyning are found.

While this system introduces a new adjustment, it does away with all oscillating secondary troubles and greatly increases the efficiency of the set.

Modern Marine Radio

By George E. Cole

A LONG the North Atlantic seaboard from Cape Hatteras to the southern tip of Nova Scotia and extending from 400 to 500 miles at sea, is a zone in which a vast amount of radio traffic is moved with an efficiency unequalled in any locality throughout other parts of the world.

The great trans-Atlantic liners, with their thousands of passengers, send hundreds of radiograms when a day or so out of the large ports and maintain communication with the American coast by means of the Chatham-Marion (WCC) station, practically throughout the voyage.

The close proximity of the Naval Compass stations, together with the high power radio telephone transmitters rapidly coming into use, naturally added more or less to the congestion of the ether and necessitated extreme measures to meet unusual and unprecedented conditions, which, up to the summer of 1921 were rapidly growing beyond control.

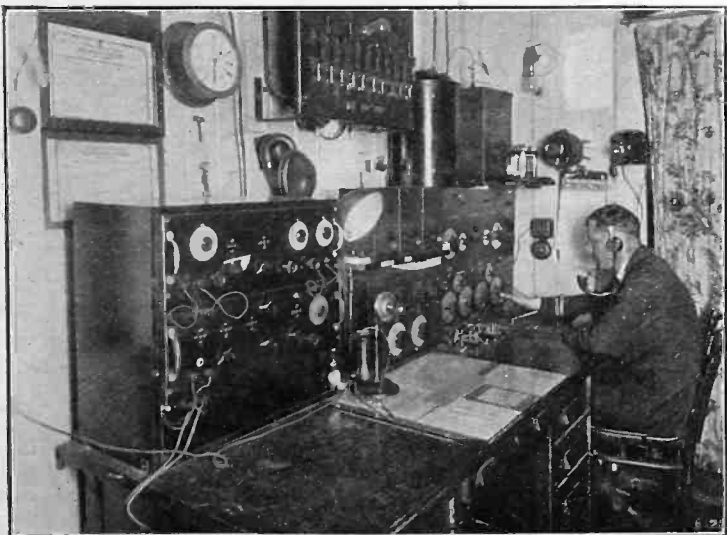

The receiving room aboard the Steamship America.

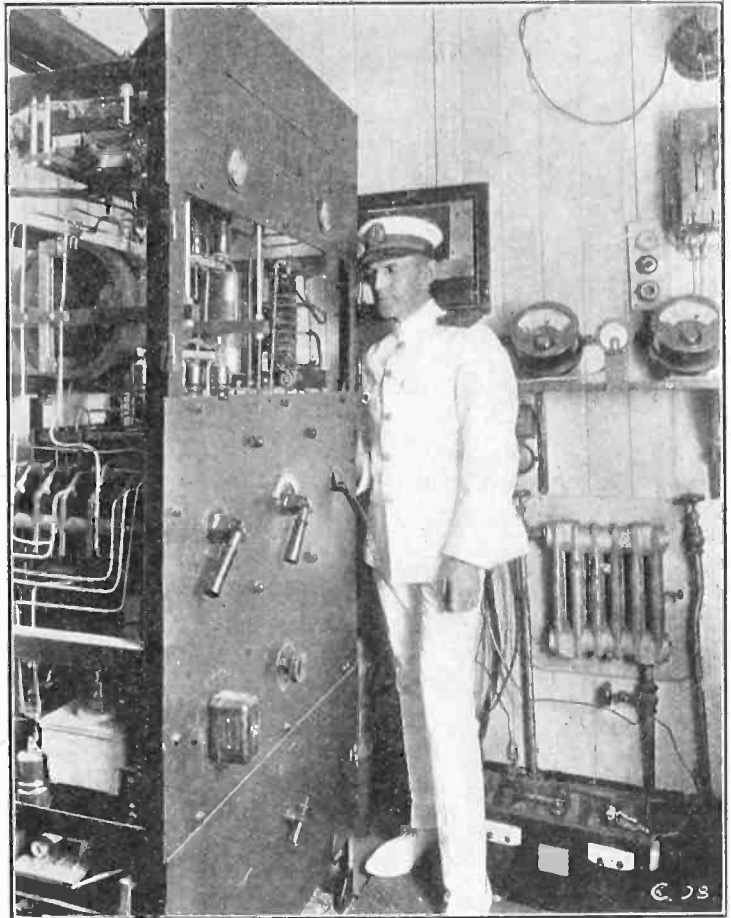

The latest design is incorporated in this transmitting outfit installed aboard the Steamship America.

The Radio Corporation of America, after a careful study of the situation, determined to meet the conditions in a broad way; not only as a business proposition, but from a firm sense of duty to the maritime interests and the public.

With the ideal of perfection of service and the advantage of ample financial and engineering facilities, a system of coastal stations for ship to shore communication has been built at strategical points along the coast, equipped with the latest developments in apparatus adequate to meet the demands of service, and manned by a personnel second to none in specialized ability to efficiently and expeditiously move radio traffic. The excellent manner in which the ship traffic is dispatched today, in contrast to a year ago is the measure of the Corporation's success in this line of its endeavor.

The system as at present constituted, consists of six stations on the Atlantic coast and one on the Pacific. They are located at Cape May, N. J. (WCY), New York City (WYN), New London, Conn. (WLC), Chatham, Cape Cod Mass. (WIM), Marion, Cape Cod, Mass. (WCC), Siasconset, Mass. (WSC) and San Francisco, Calif. (KPH).

The six Atlantic coastal stations are operated as a unit, with the Chatham-Marion station, taking the larger portion of the load and all clearing traffic to and from ships at sea through the Radio Corporation Marine Radio Bureau, 64 Broad Street, New York, by means of radio circuits of direct private wires provided for the purpose. Thus, New York has been made the point of transfer for Radio messages intended for or received from

ships at sea, and the routing "RC New York" and a single universal rate from any point, has replaced the necessity of choosing one of several available routings with as many different rates. Every American wire telegraph office has been instructed in the use of this routing and it is universally recognized and used. At "RC New York" the traffic is diverted to the coastal station nearest the ship addressed or best suited to handle it. The result is a flexible, and what is more important, a faster service than has been heretofore possible. Unnecessary stations have been dispensed with, consequently resulting in a decrease of interference, the entire handling of ship radio traffic vastly improved, and the ground work laid for further improvement of the service are now under way.

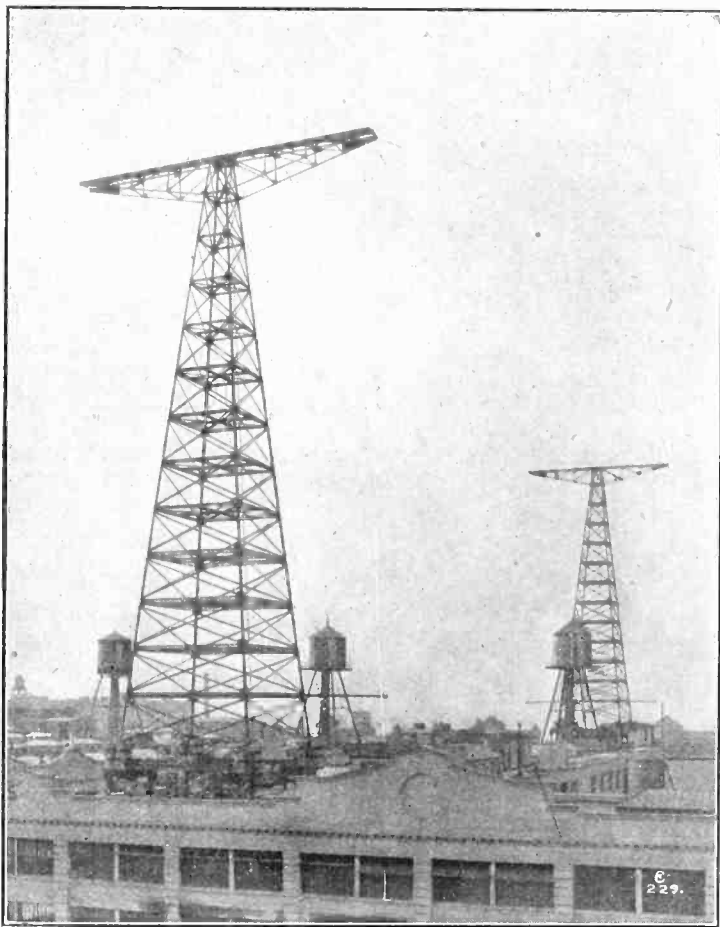

The towers of the Bush Terminal Station, Brooklyn, N. Y., WNY, used for communication with vessels at sea.

The comprehensive plan of the system may be gathered from the following outline of the stations proper. On the West coast, conditions are particularly favorable to consistent long distance working and the single station with transmitter at Bolinas, Calif., and receiver at Marshall, Calif., with private wire connections to the public traffic offices in the business section of San Francisco, Calif., are sufficient to adequately serve that port and vessels for distances up to two and three thousand miles. Communications with ships upwards of 5,000 miles are not infrequent in the Pacific.

On the Atlantic coast, the Chatham-Marion (Cape Cod) station with two continuous wave and one interrupted continuous wave tube transmitters, which work simultaneously, literally cover the Atlantic and the familiar letters, WCC, designating the station are usually heard by vessels off the

European coast before the ships with less powerful sets themselves can be heard at Chatham. The long distance receiving is by means of a so-called "wave" antenna (about 1½ miles long) which is not only directional and selective but eliminates a large percentage of static disturbances. In every respect the station is modern and designed for the special purpose of ship communication.

The stations at Cape May, N. J. (WCY) and Siasconset, Mass. (WSC) act as auxiliaries to Chatham; taking care of the 600 meter traffic in their respective zones, south and east of New York; relaying radio on long wave to Chatham and thence direct to New York for immediate delivery by telephone or messenger or to connecting land lines.

The New London (WLC) station adequately serves its zone on 600 meters, relaying traffic direct to New York City via special wires, for distribution.

As previously stated, traffic handled by these stations is cleared through RC New York, located at 64 Broad Street, New York City, from which point radiate direct private wires to the stations and direct connections with the Western Union Telegraph Company and the Postal Telegraph-Cable Company. Traffic is received and delivered when necessary or desirable by telephone. Broad 5100. The office is always open and telegraph companies or the public may always obtain any information concerning the handling of radio messages to ships at sea by calling Broad 5100 or "Servicing" RC New York.

This organized system, not only offers the public a fast and reliable communication service with ships at sea, but joins with other modern inventions in promoting the safety of life at sea. This was demonstrated only a few days ago during the accident on the steamship Adriatic when 1200 miles at sea bound for New York. Within fifteen minutes of the actual explosion, one of the Line's officers in New York was aroused from his bed by the telephone in the early hours of the morning, and consulted with the Captain of the ship by radio through the Chatham station.

Day and night, in fair weather and foul, the men in the coastal stations are listening and maintaining the unseen connections with vessels at sea. Great public servants are these men, for upon their vigilance, depends the safety of hundreds of lives at sea as well as the great property value of ships and their cargoes. But when the SOS does come, it finds these men at their posts on hair trigger, provided with every facility that careful organization and preparation can foresee and furnish to speed aid and counsel to those at sea.

Radio is usually associated in the public mind as a means of amusement or simply as a medium of sending messages. It is all of that, but the first great duty and obligation of marine radio is to bring aid to those who need it. It is a service which functions quietly and effectively, twenty-four hours a day with an efficiency which a few short years ago was never dreamed of and made possible only by the far sighted policy of the radio interest in its determination to serve.—*Telegraph and Telephone Age.*

A Short Wave Regenerative Receiver

This set is very easily constructed, is inexpensive, and will give unusually good results

By Radio Topics Institute

A GOOD short wave regenerative receiver will give more consistent, satisfactory results than any other type of set. The set to be described here will not cost over fifteen or twenty dollars, and when used in connection with one or two stages of audio-frequency amplification, it is all that the average person will want for general reception.

CONSTRUCTION

The cabinet should be about 20 inches long and 7 or 8 inches in height. The panel is hard rubber, formica or the like.

In addition to the cabinet and panel the following material is needed:

- 1 insulating tube 8" long, 4" in diameter.
- 1 insulating tube 1 3/8" long, 3" in diameter, and one six-inch shaft for same.
- 1 11 plate variable condenser.
- 1 tube socket.
- 1 grid leak.
- 1 filament rheostat.
- 2 fixed condensers .00025 cap.
- 19 contact points.

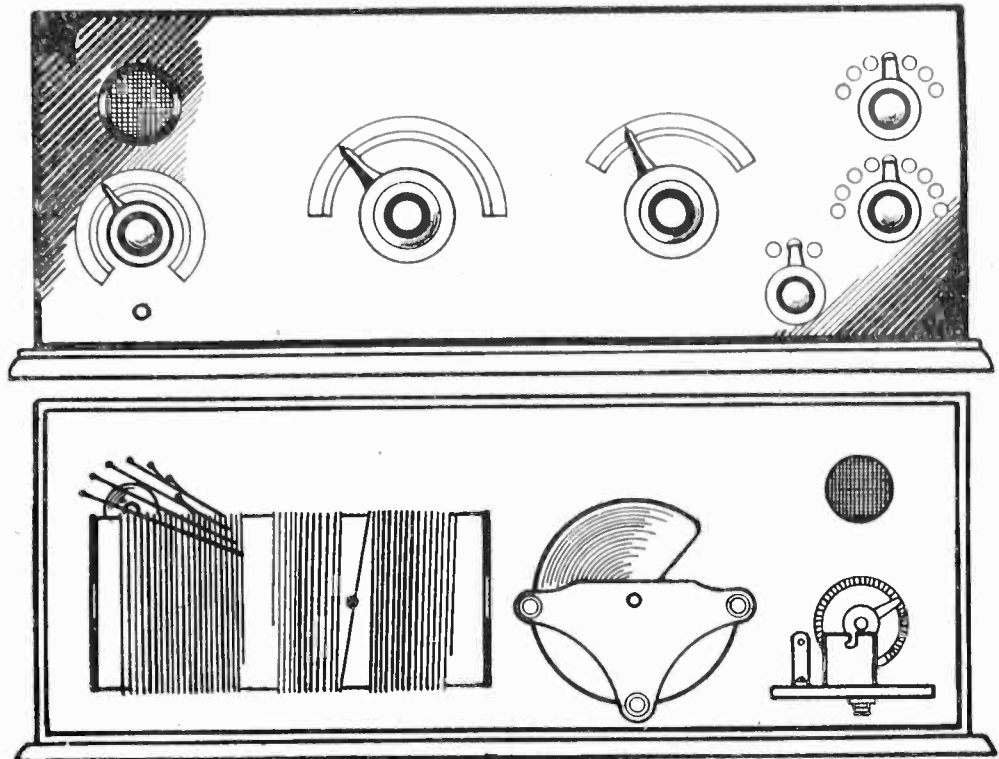

Fig. 1. Upper illustration shows the front panel view of this splendid regenerative set. Below is a rear view showing how the parts are layed out.

- 3 switch arms.
- 1 telephone jack.
- 1/4 lb. No. 24 S. C. Silk Wire.
- 1/8 lb. No. 28 S. C. Silk Wire.

In the circuit diagram the primary and secondary are shown as two coils, but in reality both are wound on the one tube, as shown in lower Fig. 1.

The primary consists of 70 turns of No. 24 S. S. C. wire. In Fig. 3 is shown the manner of winding. Start one inch in from the left end, winding the 70 turns in the section marked "A." A tap is taken from each of the first seven turns, after which a tap is taken every tenth turn. In upper Fig. 1 at the upper right hand corner is shown the contacts on the front panel to which these taps are connected.

Now the secondary. Leave a space of one inch and start winding in section "B." The secondary also consists of 70 turns of No. 24 S. S. C. wire wound with a half-inch space in the center. This is to cut down the distributed capacity of the coil and make tuning more sharp, and also to permit space for the tickler coil shaft. Thus, 35 turns are wound in sec-

(Continued on page 40)

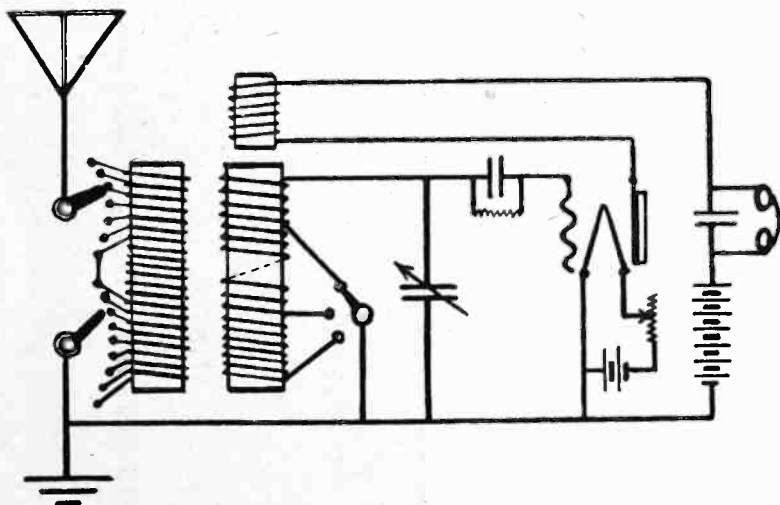

Fig. 2. This is the manner in which the set is connected. The circuit is unique and tunes very sharp.

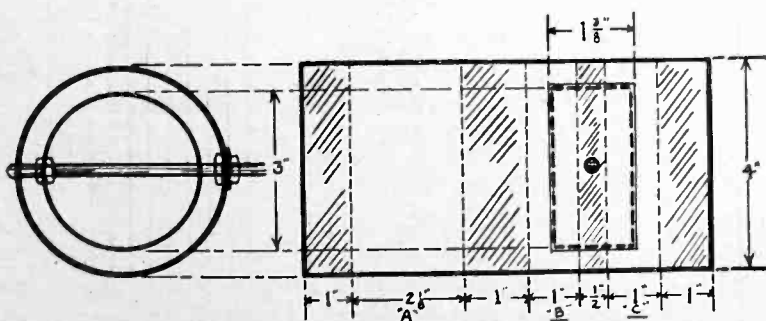

Fig. 3. Primary, secondary and tickler inductance dimensions for the receiving set described.

Radio Direction Finder and Its Application to Navigation

By Frederick A. Kolster and Francis W. Dunmore

Bureau of Standards Paper No. 428.

This is the third article, the first of which appeared in the November issue. It contains some very interesting data and experiments with radio direction finders.

As an example of a direction-finder equipment for shipboard installation, that of the lighthouse tender *Tulip* is of interest and will be described in connection with the results obtained in a series of tests conducted during the summer and fall of 1920.

The direction-finder coil is shown in Fig. 38 and consists of 11 turns of insulated wire wound on a rigid skeleton frame 4 feet square. The coil is attached to a shaft which extends into the pilot house through suitable bearings and which is supported on ball bearings in order to permit ease and uniformity of rotation.

Another view of the direction-finder coil is shown in Fig. 39 where it is seen directly over the pilot house and on the center line of the ship. The interior view of the pilothouse, Fig. 38, illustrates the method of attaching the direction finder to the binnacle carrying the magnetic compass. By means of this arrangement radio bearings are observed in a simple and direct manner. The exterior coil is rotated from within the pilot house by means of a handwheel, and the bearing of the signaling station is read directly on the magnetic compass card. In Fig. 40 the captain of the *Tulip* is seen taking the radio bearing of the Fire Island light vessel.

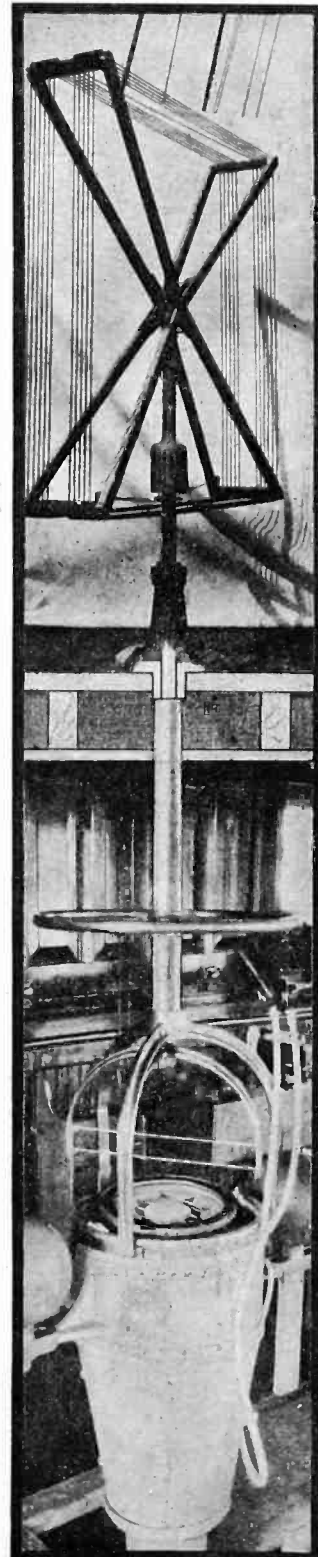

Fig. 38.—Magnetic compass with direction finder attachment for reading the radio bearing directly on the magnetic compass

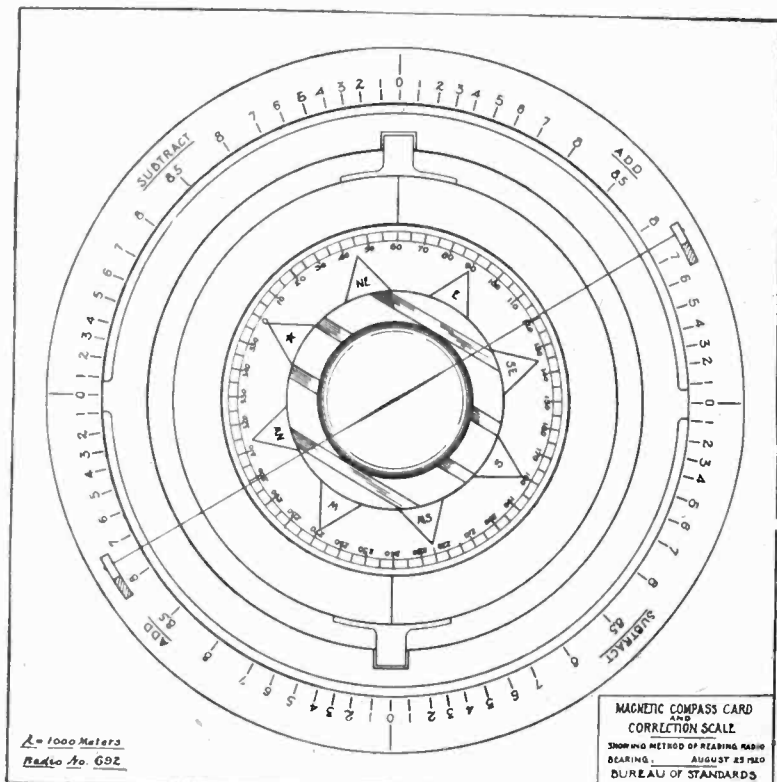

Fig. 42.—Magnetic compass card and correction scale showing the direct-reading method of obtaining a corrected radio bearing

A calibration or correction curve for the *Tulip* direction finder was obtained by taking simultaneous visual and radio bearings on one of the light vessels while the *Tulip* made a circular course at a distance

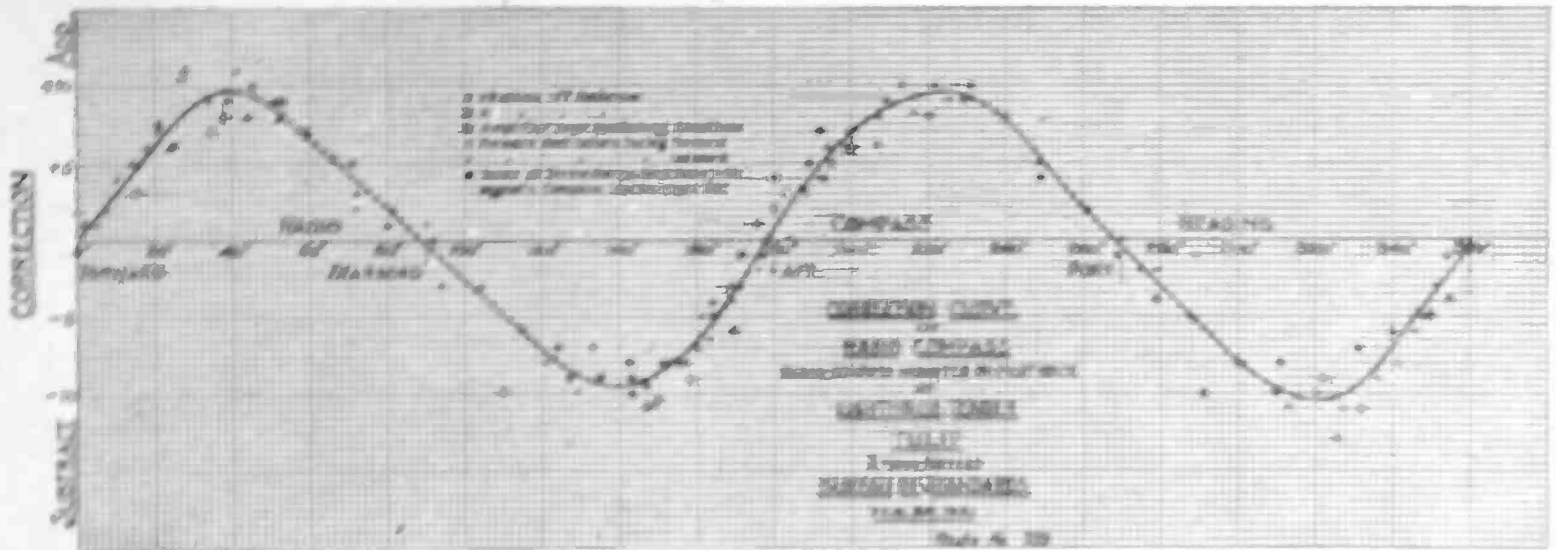

Fig. 41.—Correction curve for direction finder installed on lighthouse tender "Tulip"

of a few miles from the light vessel. This correction curve is shown in Fig. 41, and it will be noted that it approaches very nearly a sine curve. It will be noted further that maximum deviation from true direction occurs when the direction of approach of the signaling wave is approximately at 45 degrees with the ship's center line; that is, when the mass of the ship assumes an unsymmetrical relation with respect to the approaching wave front. In the fore-and-aft direction and directly abeam the deviation is zero or nearly so because of the more or less symmetrical arrange-

ment of the ship's mast with respect to the direction of approach of the wave front. This, of course, holds true only when the direction finder is located approximately amidships.

Once the correction curve has been obtained for the particular wave length assigned to the radio fog-signaling stations or radio beacons, a correction scale may be made in accordance with the curve, which, if attached to the binnacle as shown in Fig. 42, provides convenient means for reading the bearing and correction simultaneously.

The electrical circuit of the direction finder is given in Fig. 43. The variable condenser C_1 , together with the coil L_1 , form the main receiving circuit which is tuned to the signaling wave length. Connected across the condenser C_1 , either directly or through a potential transformer P , is the vacuum tube amplifying and detecting apparatus D . This consists of a three-stage radio-frequency amplifier, a detector, and a two-stage audio-frequency amplifier made up as a unit with a minimum number of operating adjustments.

The telephone receivers T are located in a fixed position at a sufficient distance from the magnetic compass to avoid any effect on the compass due to the magnets within the telephone receivers. A brass tube is attached to the telephone receivers as shown in Fig. 44 with flexible rubber tubing completing the circuit to the earpieces worn by the observer. By the proper choice of the length of the brass tube a desirable quantity is given to the signal tone by virtue of acoustical resonance.

We now come to the auxiliary circuits of the direction finder which are controlled by the switch S . With this switch closed to the right the middle plates of the double condenser C_2 are directly grounded. The double condenser is utilized to bring about electrical symmetry of the coil system with respect to the earth. In other words, by adjusting the middle plates of the condenser C_2 to the right or left, the earth connection is brought to the electrical mid-point of the coil system, and the parasitic effects described earlier in the paper are eliminated, that is to say, the signal received in the telephones T results only from the energy directly received in the coil L_1 .

With the switch S closed to the left a small condenser C_3 is connected across half of the double con-

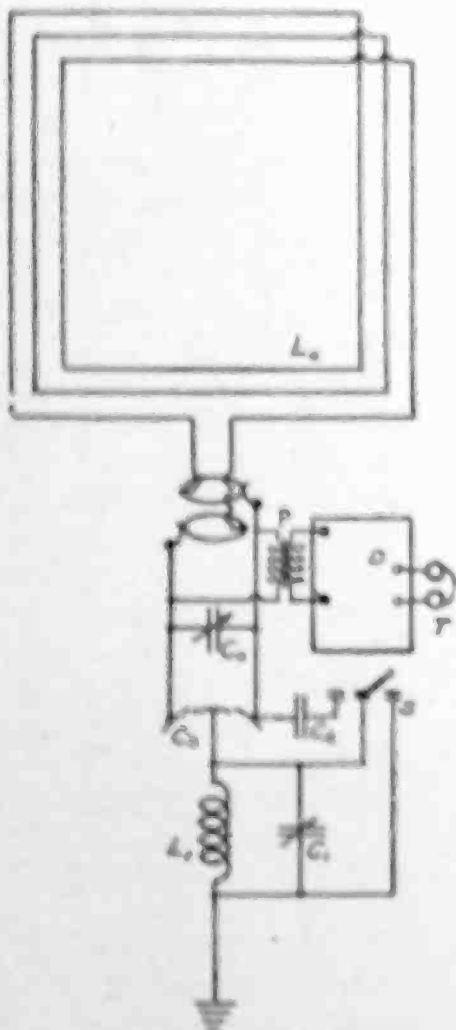

Fig. 43.—The direction finder circuit

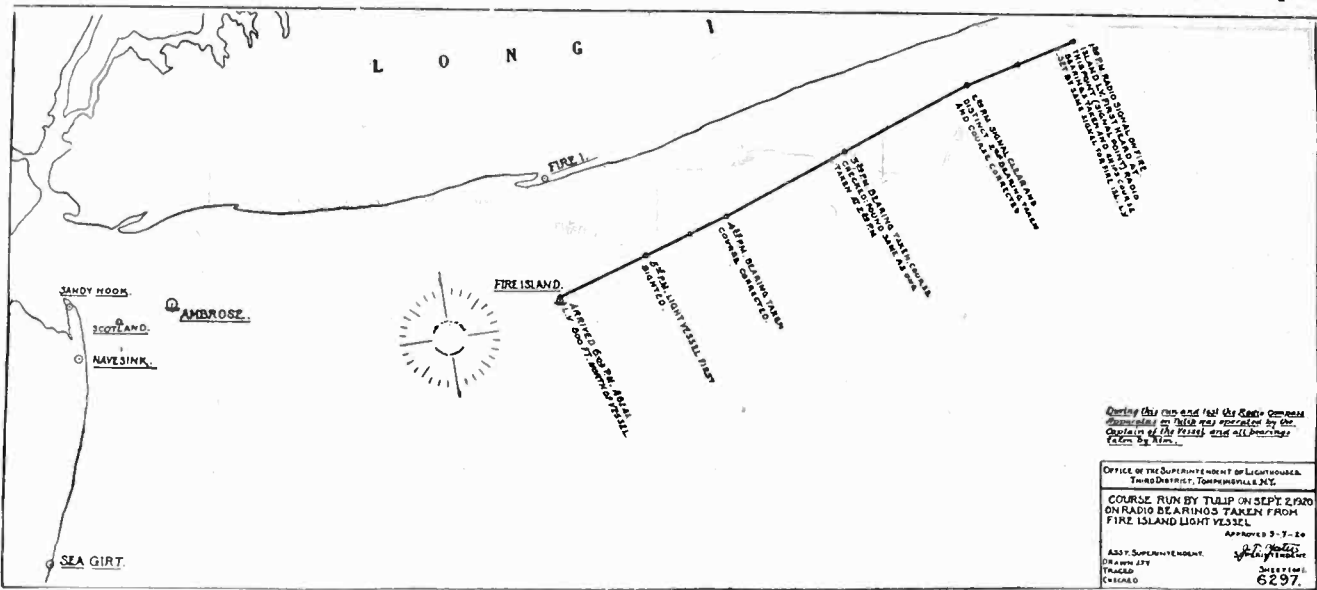

Fig. 46.—A run made by the lighthouse tender "Tulip" navigated entirely by the radio direction finder

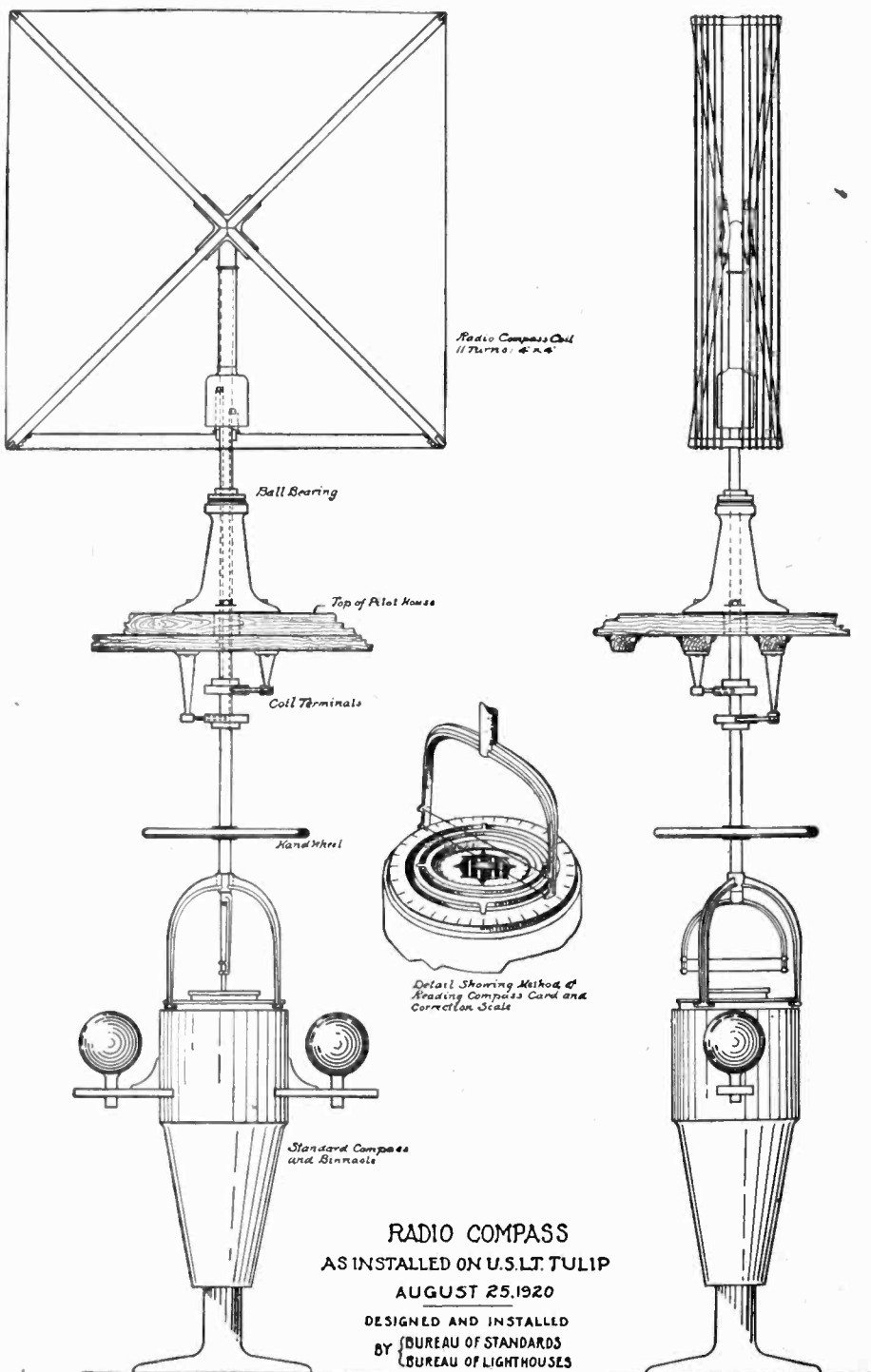

Fig. 45.—Radio direction finder as developed by Bureau of Standards and Bureau of Lighthouses.

denser C_3 and the inductance L_1 and tuning condenser C_1 are inserted in the ground lead. Under these conditions the coil system is no longer electrically symmetrical with respect to earth, and received energy enters the coil circuit L_0C_0 indirectly through the tuned ground circuit of which the capacity of the complete coil system to earth forms a part.

By the proper adjustment of the capacity C_2 and the circuit L_1C_1 , a complete unidirectional effect can be obtained as previously described.

In the practical operation of the direction finder, all tuning adjustments remain set for the 1,000-meter wave length of the signaling stations. Switch S is closed to the right when observing the line of direction of a given signaling station and to the left when it is desired to determine the sense of direction. In other words, to determine the line of direction of a station, the coil system which is directly grounded at its electrical mid-point by throwing switch S to the right is rotated to the position of critical silence, at which time the plane of the coil is normal to the direction of approach of the signaling wave. To determine the sense of direction of the station, switch S is closed to the left and the coil rotated to the position of maximum signal intensity, at which time the plane of the coil is in the direction of approach of the signaling wave and pointing toward the signaling station as indicated by an index pointer provided for that purpose. The complete direction finder system is shown with details in Fig. 45.

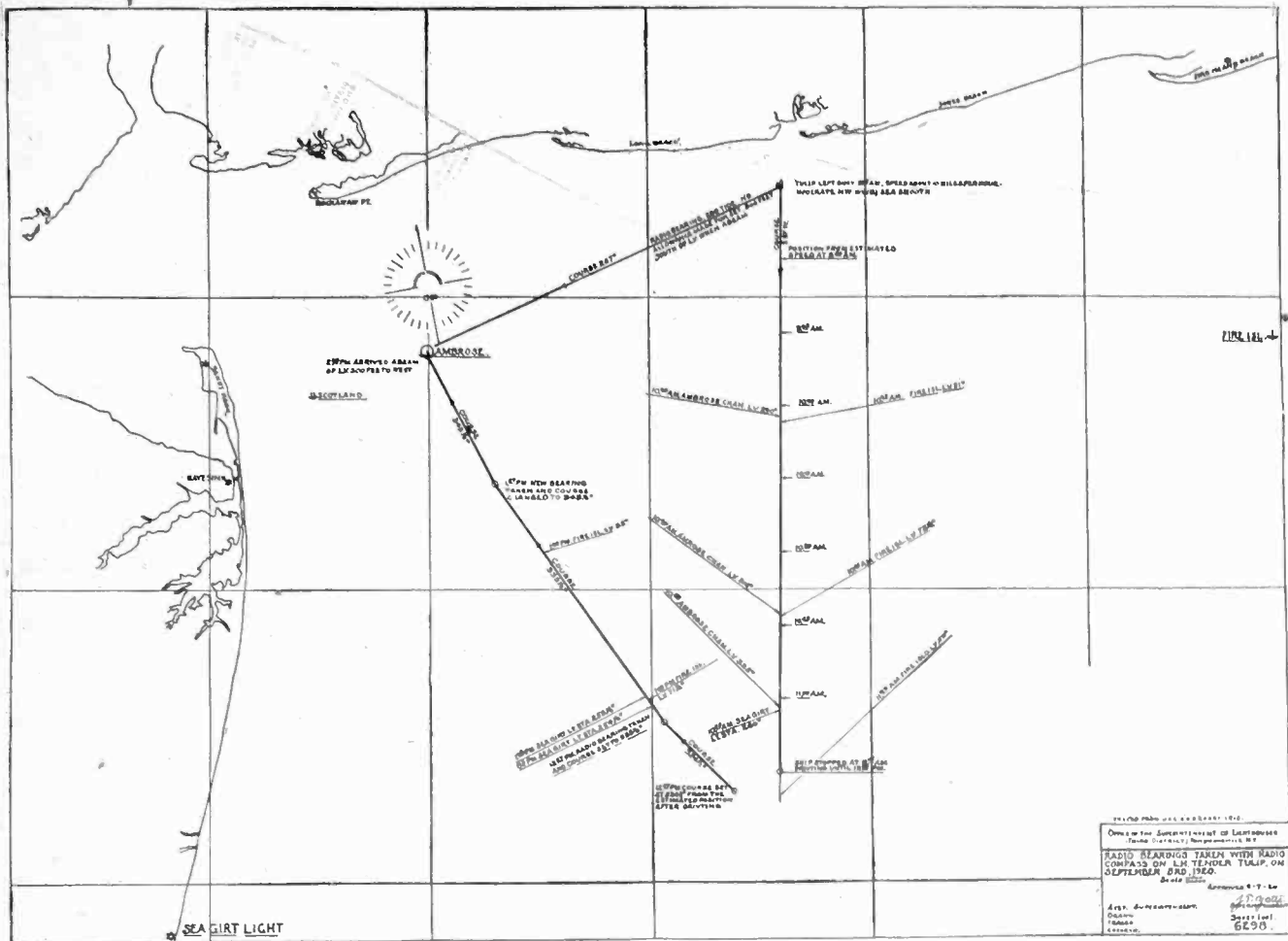

Fig. 47.—Runs made by the authors entirely by radio bearings

The results of actual tests conducted under most practical conditions are shown by the charts, Figs. 46 and 47, which are self-explanatory.

The 45-mile run shown in Fig. 46 was made on radio bearings taken from the signaling station on the Fire Island light vessel. During this run the direction

finder was operated and all bearings taken by the captain of the tender *Tulip*, who had had no previous experience in the operation of any kind of radio apparatus.

In Fig. 47 the estimated positions of the *Tulip* at quarter-hour intervals are given during the south-by-west course taken from Jones Inlet buoys. The true position of the ship, as determined by radio bearings taken on two of the three signaling stations, is also shown in several instances.

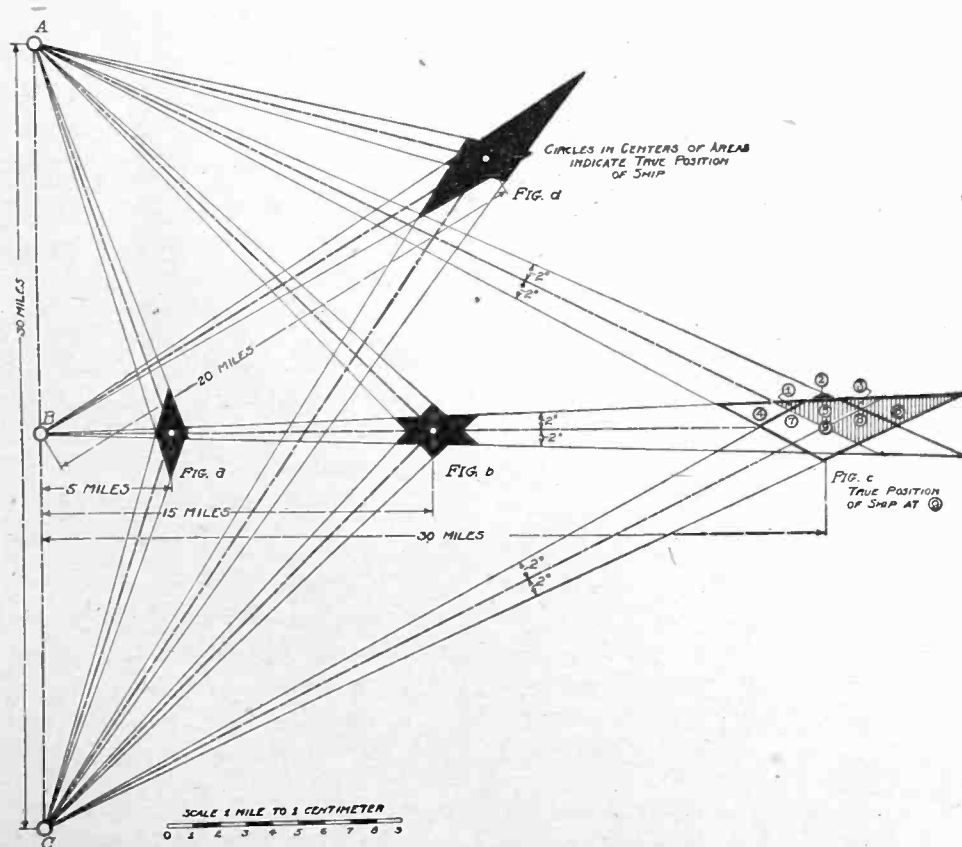

Fig. 48.—Accuracy of radio triangulation

The accuracy with which the position of a ship may be determined by triangulation, resulting from bearings taken by radio on two or more signaling stations, depends, of course, upon the sense, whether positive or negative, and order of magnitude of the possible error made in observing the radio bearing of each of the signaling stations. Theoretical triangulations are shown in Fig. 48, in which an exaggerated error of plus or minus 2 degrees is assumed in each case. Any set of three observations or bearings will locate the ship within a triangular area, but the true position of the ship may be entirely outside of this area but within a star-shaped area formed as shown in Fig. 48, the details of which are shown in Fig. 49.

IV. CONCLUSION.

In conclusion it may be definitely stated that the radio direction finder, or radio compass, as herein described, is an extremely effective aid to navigation, particularly in fog or thick weather. If properly constructed, installed and calibrated, it can be depended upon to give reliable results. The device is essentially a nautical instrument and should be installed on shipboard, where it may be used directly by the navigator in taking bearings on signaling stations established on shore or on light vessels. Bearings may thus be taken at any time and as often as desired.

The reverse method of locating direction-finder stations on shore and requiring the navigator of a ship to make a request for his bearing or position from time to time, as conditions may permit, is fundamentally wrong. Delays and errors are inherent, and even under the most favorable conditions the time consumed in making a request for bearings, taking bearings, and getting the information into the navigator's hands, is too great.

The maintenance of a 24-hour service at the required number of shore direction-finder stations requires a large operating personnel, continually on watch, but only occasionally called upon for service. This places great responsibility and expense upon the government.

Signaling stations, whose locations are accurately shown on mariners' charts, may be established at light-

houses and on light vessels at very little expense. Such stations would thus become a part of an already well-established service whose function is strictly that of maintaining aids to navigation. No additional personnel is required since the operation and maintenance of the radio-signaling apparatus would be the duty of the light keeper.

The cost of the radio direction-finder equipment for shipboard installation is so small as compared with the benefits which may be derived therefrom, perhaps in a single instance, where life, property, or even time may be saved, that it cannot enter into consideration.

The utility of the direction finder on shipboard goes further than that of taking bearings on known stations on or near shore. Other ships at sea, perhaps in distress or in fog, can be located and their course determined. As a matter of safety, every ship at sea in fog should send out radio fog signals at frequent intervals, effective over a distance of at least 10 miles. This would enable another ship within range equipped with a radio direction finder to determine the direction and course of the signaling ship and thereby proceed with safety and without delay.

The work of the Bureau of Standards herein described has been conducted with the assistance and close co-operation of the Bureau of Lighthouses and particularly of the lighthouse depot at Tompkinsville, N. Y.

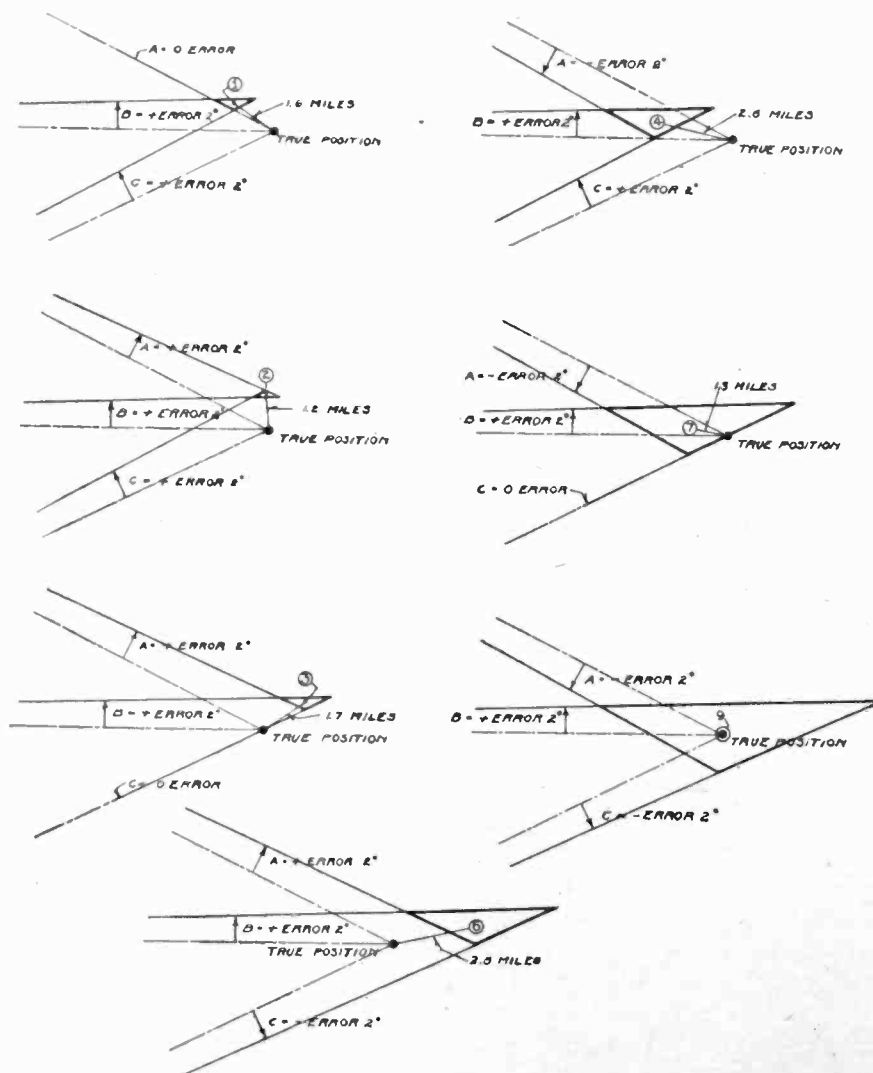

Fig. 49.—Accuracy of radio triangulation, showing true and observed position

Elementary Electrical Principles

*Learn them well, apply what you learn, and you will be a better radioman
and have a more efficient station*

By Harvey Mitchell Anthony

IT IS the purpose of this article, which we will call lesson 1, to introduce the most fundamental ideas dealing with the electric circuit. If the student who is about to enter into wireless will read and study each succeeding article in a thorough fashion, he will soon find himself well equipped with sufficient training to advance from the simple to the complex.

The first thing we should devote our attention to is the basic laws governing the flow of electricity in power circuits. We assume that electricity is something which is always present, which is round about us at all times in what may be called a stationary form. Now, the most important thing which is necessary is to create some method of making this electricity move. We may liken electricity to a mass of water in a lake. The water is there, but if we wish to make it move in order to obtain from it power, we must apply some pressure to bring about this movement. Take, for example, the water in your river or well. How are you going to get this water from the river or well up to your house, which is located several miles distant? It must be admitted that pressure is necessary, so in the case of water we must apply a pump to force that water through the pipe. So is this true with this great big reservoir of electricity, and then if we provide a suitable channel through which it may be conducted, current will flow. This we will call the electric current. The pump which is used in pushing electricity through this channel is called the electric generator. The generator will drive the current through the wire just as the water pump drives the water through the pipe. This electric pressure apparatus may be a dynamo, or it may be a battery. We will confine our attention at present to the former and allow the battery to be taken up in another

About two years ago, when Radio Topics was a young publication, we published a series of these articles on Elementary Electrical Principles and their application to radio. To really understand radio one must learn the principles of electricity.

When these articles were originally published our circulation was only five thousand, but it created such great interest because they were so splendidly written that we feel that now, when these splendid lessons will benefit over 90,000 readers, they should be republished.

As a special incentive we offer a \$200 receiving set to the one with the highest average percentage during the series. Type your answers or write in black ink on one side of the sheet. Go to it now—you will find these articles the most interesting and instructive you have ever run across.

lesson. In the case of water the pressure is reckoned in terms of pounds; that is, so many pounds of pressure. In the case of the dynamo we reckon the pressure in terms of VOLTS. It is obvious that if we have 100 volts applied to electricity that the current will flow 100 times as fast as it would if we only applied 1 volt (provided we use the same size conductor and retain the same length). If 100 volts will not pass the necessary current through the conductor, then we will have to increase the voltage or pressure up to the proper point when the required current value will be reached. In cases where transformers are used for wireless sending sets, the city voltage is usually applied, and the ordinary pressure under these conditions is approximately 110 volts, this being the common

house lighting voltage in most cities.

Now, assuming that we apply this 110 volts pressure to an electric circuit, a current will flow. However, we must be able to regulate this current, for too much of it will burn out our apparatus. Voltage is only one of the considerations which determine the current strength. Probably the most important is electrical resistance. Resistance is without doubt the most general property of all power circuits and should be carefully studied by the student. In the case of water flowing through a pipe, the water must actually move from point to point, from the pump to the receiving end, where it is to be used. Wherever the body of water moves the channel through which the flow takes place offers more or less opposition to the flow. That is, the water pipe has certain properties which will regulate the flow to a large extent. It is plain to be seen that if the pipe is small in diameter the flow will not be as easy as it would were the pipe of large cross-section. The pipe also has an inside surface upon which the water rubs when flowing, and this inside surface will offer more or less opposition. If the pipe is twice as long (and of the same area) it will offer twice the resistance. Hence we find in the flow of water this important factor of opposition offered to the flow. In electricity we find exactly the same thing. The unit of electrical resistance is the OHM. In electricity we deal with wires just as in water we deal with pipes. Wires have certain properties and the laws governing electrical resistance in these wires will be explained briefly as follows:

(1) The electric current is conducted through a wire and not along its surface. Thus a wire having twice the cross-sectional area will carry twice the current. The larger the wire the less will

be the resistance offered to the current flow. The smaller the wire then the greater will be the resistance. Wire sizes are rated in circular mils. The circular mil is the area of a wire whose diameter is one mil (one-thousandth of an inch). A number 14 Brown & Sharp wire is one having a cross-sectional area of 4107 C. M. A number 6 B. & S. wire has a cross-sectional area of 26250 C. M. Thus we can plainly see that the No. 6 has over six times the area of the No. 14, consequently the resistance of the No. 6 will be about one-sixth that of the No. 14. By increasing the size of a wire we can reduce the resistance. This factor of resistance is very important in radio circuits, and unless we watch it pretty carefully trouble will arise and our circuits will be inefficient. The advice is to make the resistance as low as possible by using wire of the proper size.

(2) The resistance of a conductor is directly proportional to its length. A wire, say a No. 14, has a resistance of 2.5 ohms for every 1,000 feet of length. If the line is made 2,000 feet long, then the resistance will be doubled and the actual resistance will be 5 ohms. On the other hand, if only 100 feet of this wire is used, the resistance will be one-tenth of the thousand foot resistance value, which will be one-tenth of 2.5 ohms, or 0.25. It is my advice to the wireless man to make his power leads as short as possible, thereby reducing his resistance.

(3) The resistance of a conductor depends largely upon the material with which the conductor is made. A silver wire would really be the best conductor we could use, but unfortunately the cost of silver prevents us using it in our radio circuits. The next best conducting material is copper. Copper is what we employ in our electric lines. A pure element, is as a rule, a better conductor than an alloy. Silver is the best, copper next, aluminum next, iron next and German silver last. These are materials out of which conductors might be made. Iron has about six times the resistance of copper and German silver has about twelve times the resistance of copper. For this reason iron and German silver are both used for making resistance coils, for they offer

considerable opposition to the passage of electric current. Resistance, being so important in radio work, deserves a lesson in itself, and such a lesson will be considered later.

(4) The resistance of a conductor depends largely upon the temperature of the wire when the current is flowing. As a wire becomes warmer its resistance increases. Thus, when you overload a conductor and pass more current through it than it can safely carry the resistance value rises greatly, according to the temperature reached. In many forms of electrical practice temperature is a very important item and must be safely guarded against or considerable loss of energy will arise.

Therefore, in planning electrical circuits we should be careful to observe the foregoing points; namely, wire size, wire length, kind of wire and heat developed during the flow of the current. A proper consideration of all these items will result in higher efficiency of the complete radio circuit, which will consequently mean greater energy output. Energy output is that which all amateurs are interested in, and the above stated principles will apply in wireless from the source of voltage supply clear through the circuits to the very extreme end of the aerial.

The relationships existing between voltage, current and resistance are shown in the following formula known as Ohm's law. This law is the fundamental law governing the flow of the electric current in conductors, and without the law electrical engineering today would be unable to solve the great problems placed before it. If you as a student are well acquainted with this little bit of mathematics you will begin your first step toward the successful and practical solution of problems in electrical work.

The unit of pressure is the VOLT. The unit of current is the AMPERE. The unit of resistance is the OHM.

$$\text{VOLTS} = \text{AMPERES} \times \text{OHMS.}$$

$$E = I \times R$$

Where E is equal to the voltage or electromotive force; I is equal to current intensity (in amperes); R is equal to resistance (in ohms).

It is advisable for the student

to learn this formula as quickly as possible and also learn how to apply it to circuits. A good way to learn the formula and remember it is the following method: Place the E over the I x R thus,

E.
I x R Now if you wish to find the current, place your finger over the I in the formula and you have E divided by R. Then solve your problem by using the numerical values for I and R. In the same manner, if wish to find the resistance, place your finger over the R and you have the E divided by the I. If you wish to find the E, place your finger over the E and you have I multiplied by R.

The following problems should be worked out by the student. Make practical use of the above formulas:

1. What voltage is necessary to force a current of 5 amperes through a coil of wire which has a resistance of 24 ohms?

2. What current will flow through the filament of an incandescent lamp having a resistance of 58 ohms, when the applied voltage is 116?

3. How much resistance is there in an electric stove if the current registered by the ammeter is 4 amperes and the house voltage is 110?

4. A generator is supplying 220 volts to a lamp which has a resistance of 44 ohms. How much current will the lamp receive? Suppose the resistance remains constant and the voltage is cut down to 110. Then how much current will pass through the lamp?

Answer the following questions:

1. Explain what you mean by electric pressure and give its unit.

2. Explain what you mean by electric current and give its unit.

3. Explain what you mean by electric resistance and give its unit.

4. What effect has the pressure or voltage on the flow of current?

5. What effect has resistance on the flow of current?

6. Name the various factors which determine the resistance of a conductor carrying electricity.

7. Why is it not advisable to use too small wire when install-

(Continued on page 36)

Our Radio Shopping Service

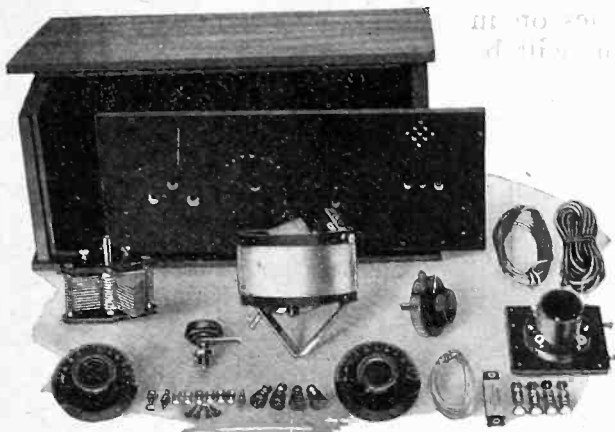

The Waveland Knockdown consists of the necessary parts for a complete tuner and detector and costs \$20.00.

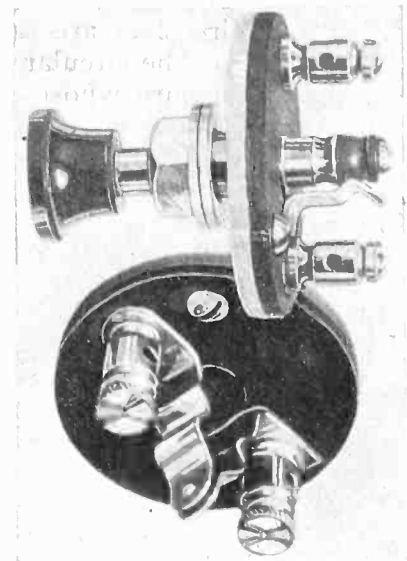

Two views of the improved Anti-Capacity Jack, small and neat.



The Pacent Duo Jack is a handy accessory and is \$1.50.

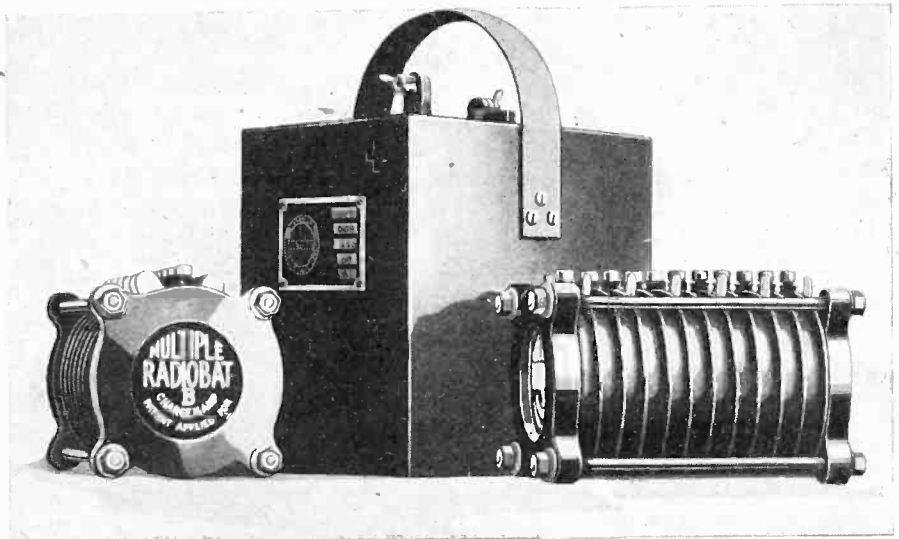

A group of A and B Storage Radiobats which do not use any separators. Both cells are readily recharged at home.



A vernier coil is the feature of the Fletcher Variometer, which permits of fine tuning and quick adjustment. Forms are of genuine mahogany wood. Complete at \$6.00.



NOW CUSTOMERS RECEIVE BETTER SERVICE

Orders received after the truck has left the bakery are transmitted by radio telephone to the driver who can make immediate delivery. Instantaneous communication is possible even when the truck is farthest away—75 miles from the plant.

How Radio Increased Good-Will for 9 Concerns

Some of the ways in which this new means of communication has enabled business men to build sales, give better service, and obtain valuable publicity.

CAN the radio telegraph be employed profitably in business? The rapid increase in the number of firms using the radio telephone and the uses to which they are putting it, makes it plain that, in business, radio has been taken from the category of fads to fill a genuine need.

Farmers within a 700-mile radius of New Lebanon, Ohio, are reaping the benefits of the radio telephone broadcasting station installed by the Nushawg Poultry Farm a few months ago.

"Prior to the time we installed our outfit our farm was just about unknown," says W. N. Nushawg, general manager. "Within the first three months we had over 4,000 inquiries about our products—and this covers the 'static season' when our range has been necessarily diminished.

"Rural districts supply 90% of these inquiries, because this station broadcasts information intended primarily for the farmer. On Friday evenings we transmit information on hog feeding, dairy feeding, and poul-

try culture. Authorities on these subjects supply the information.

"On our other two broadcasting nights, Monday and Wednesday, we send information supplied by state institutions and the Department of Agriculture, along with talks on education, art, religion, and commerce. The farmer has been put in touch with cultural forces which he appreciates, but seldom encounters. And he is grateful for our service.

"The return to us has been a hundredfold what we have spent on radio. We have created valuable good-will which has resulted in the growth of our business and a much wider distribution of our products."

Direct advertising by radio is not encouraged by the national government and will probably be prohibited. The Westinghouse people advertised electrical devices at the start of their broadcasting work; but they soon desisted because they found that the public did not like it.

The Kolb Bakery Company of Philadelphia has put radio to an

interesting use. The large truck of the company which makes a daily trip of about 130 miles has been equipped with a receiving outfit. Messages broadcasted for the truck while it is in motion are received by the man who runs the truck.

"We do not use radio for any other purpose than to keep in constant touch with our truck," says an official of the company. "In our business we feel that anything which tends to give our customers better service is profitable to the business.

"This truck makes a daily trip to points as far distant as 75 miles from the plant. Radio enables us to keep in touch with the man on the truck at all times."

Most department stores which have installed radio sending equipment have done so for the general publicity it gives them. Gimbel Brothers, at Philadelphia, have found a more direct way to benefit.

Radio broadcasting has developed several tangible sources of profit for Gimbel's besides the somewhat less tangible value of getting the firm name before people in approximately 10,000 homes daily. The sales of accessories alone have run into many thousands of dollars and have more than paid the cost of rather expensive equipment, according to Ellis A. Gimbel, Jr.

Not one of the ideas developed by the store, however, was put into effect with the expectation of direct profit. Broadcasting was started for its indirect publicity value as an aid to sales, and was charged accordingly on the books. The original program included musical selections, late news items and other popular broadcasting stories for children in the name of "Uncle Wip"—WIP being the store's call.

To test the interest in various numbers on the program, Gimbel's hit on the plan of asking children listening to the bedtime stories to send in their names promising to announce them on the next night's program. The response was so gratifying that a general call was sent out each night for suggestions to improve the program. Then the listeners

were asked to present their radio problems for discussion and advice.

The firm now has a mailing list that could not have been purchased. It contains several thousand names to date, and the list is growing at the rate of from 50 to 200 per day. So far no attempt has been made to use these names for direct mail advertising, which is the ultimate intention. Before that is done the list will be classified by analyzing the letters on which it is based, to determine approximate future needs and sales possibilities.

Conditions under which this firm launched its broadcasting, offer a valuable guide to others. Ellis A. Gimbel, Jr., has been a "radio fan" for about 10 years. Developments soon convinced him that use of the radio telephone should be handled with extraordinary care. It was necessary to exercise the utmost vigilance in the purchase of equipment and also to take pains to explain to casual customers adverse conditions which might interfere with broadcasting.

Some months ago an arrangement was entered into by three of the Philadelphia department stores to avoid duplication of broadcasting. The Gimbel station experimented with the whole range of music and its weekly program now runs the gamut from jazz furnished by a popular cafe orchestra to chamber music. In both cases the call for suggestions and criticisms led to these numbers.

Then—again as a result of repeated suggestions—wires were connected with Trinity Memorial Chapel, one of the centrally located Episcopal Churches. Services morning, afternoon and evening are broadcasted from the Gimbel station, including sermons, the choir singing, responses by the congregation and other services. The appreciation shown was a revelation. Hundreds of enthusiastic letters have come in praising the plan. Many are from persons of different religious denominations who take pains to point out that fact, but do not demand broadcasting from their own churches. No effort has been made to get expression of opinion on the religious broadcasting on Sundays.



THE INVISIBLE FRATERNITY OF THE AIR

STATION MARION

ILL.

DATE JULY 15

1922

JAMES WILSON

HAS PAID DUES TILL

July 15

1923

AND IS A MEMBER IN GOOD STANDING OF THE
EGYPTIAN RADIO BUGS

HEADQUARTERS
MARION, ILL.

AND ENTITLED TO ALL PRIVILEGES

PRES.

Jay Luystert
CHIEF BUG

J. M. Crulehfield
Zoe D. Campbell
SEC.

"THE BEST PUBLICITY STUNT YET"

Thus the Cline-Vick Drug Company regards "The Egyptian Radio Bugs," of which the membership card and pin are shown. Members share in the use of radio telephone receiving sets purchased through the drug company.

Every letter received is answered on a special form of stationery, whether or not a request is made for information. Most of the answers are merely letters of thanks or expressions of appreciation. No advertising matter of any kind is permitted to get into these letters.

Among the other subjects on the Gimbel program that have proved popular are weekly lectures by Scoutmasters to Boy Scouts. The scouts are informed that any questions they may wish to ask will be answered and hundreds of letters are the result. The constant rise in sales of accessories to boys shows the value of those features as sales attractions. At the same time the firm is not losing sight of future prospects among adults; this is evidenced by the rest of its program.

"Excellence in the program and painstaking explanations to amateurs, young and old," says Mr. Gimbel, "are essential to the future of radio. We come in contact with scores of adults who get disgusted after the first trial, made perhaps with inferior equipment and under adverse conditions. The thing we see to avoid in the radio department is exaggeration. It has already harmed the future of the industry."

Broadcasting stations are apparently essential to the sale of receiving sets, but the problem in this regard is to offset the cost of operation. Under present conditions anyone can purchase a receiving set, and barring the small cost of new parts to replace those worn out and of charging batter-

ies he can utilize it indefinitely without further expense. Many concerns are finding, however, that radio equipment more than pays for itself in direct ways.

For instance, there is the general store of a small town merchant. An investment of \$200 brought the store the biggest day's business in its history and ever since has been responsible for a steady increase in volume. This town is without a newspaper and its mail service is infrequent. The merchant saw his opportunity, bought a radio telephone outfit for \$200, and told his customers that he would give a concert every night. The first night his store was crowded to capacity and the crowds have been coming every night since then. Every evening the store receives market reports on cattle, sheep, hogs, produce and grain. These reports are telephoned to any farmer who asks for them. Information which is of general interest is posted on a bulletin board outside the store which always attracts a crowd.

The Cline-Vick Drug Company operating a small chain of drug stores in Southern Illinois is responsible for a novel organization, "The Egyptian Radio Bugs." The idea was conceived to stimulate the sale of radio outfits and to bring about a popular appreciation of the radio telephone. Since its organization, however, the Cline-Vick Drug Company has found that the direct advertising afforded by "The Egyptian Radio Bugs" surpasses any other publicity stunt ever attempted for advertising purposes.

(Continued on page 38)

Department of RADIO ENGINEERING

Radio Topics Institute

Nanko C. Bos, Chairman Advisory Board



Our Efforts

to standardize and better radio merchandise is indeed bearing fruit. It is a common occurrence for buyers today to demand tested and approved apparatus. The unknown manufacturer is finding it more and more difficult to sell his products. Send all inquiries and material for test to RADIO TOPICS INSTITUTE, Oak Park, Ill.

The Test and Standardization of Condensers at Radio Frequencies

THE purpose of this article is to describe some detail the comparison of the capacity and effective resistance

or phase difference of two condensers, one of which has already been standardized. This process is therefore a secondary standardization.

The primary standardization requires a condenser whose metal parts and contacts are such that the conductor resistance is negligible, and whose insulating parts are so chosen and placed that the (effective) dielectric resistance is also negligible. Such a condenser may be standardized at a low frequency by a fundamental method and subsequently used at radio frequencies with confidence that the capacity is independent of frequency and that the effective resistance is negligible. In the ab-

sence of such a primary standard, recourse may be had to a condenser which has been compared with a primary standard.

The method here described is that of comparison by substitution, that is, the tested and untested condensers are compared by inserting them in turn in a circuit which is brought to resonance with a source of undamped waves. The apparatus required is, then, a standard condenser, an inductor to form a resonant circuit with the standard condenser or the condenser under test, a current-square meter or radio-frequency ammeter, and an electron tube generator. If only capacity comparisons are to be made and not resistance measurements, the current-square meter or ammeter may be replaced by any device capable of indicating resonance, and the electron tube generator may be replaced by a generator of damped waves if the latter is more available than the former, and is constant in frequency and power.

If comparisons are to be made frequently, it will be found useful to have a special set allowing quick and easy interchange of the two condensers in the tuned circuit. An example of such a set is

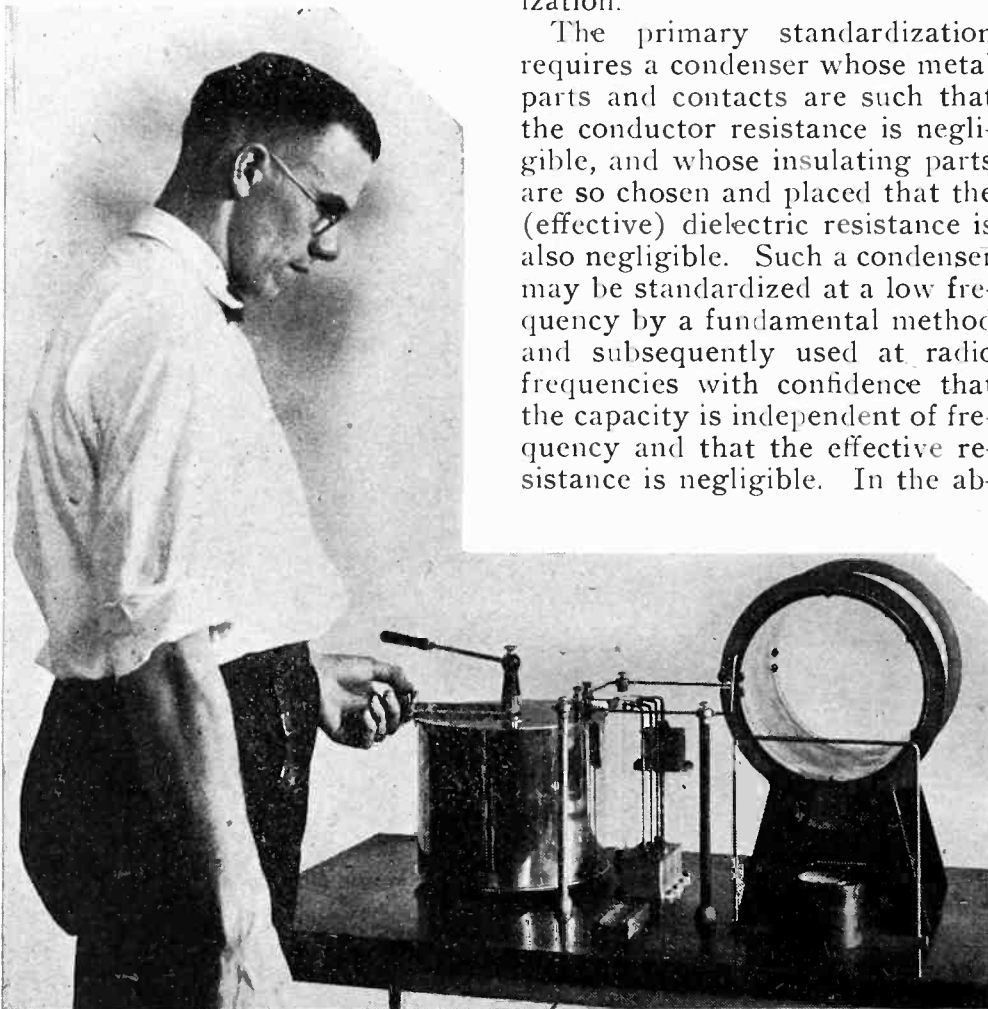

the condenser comparison set, type K 507 B of the Bureau of Standards, a diagram of which is shown in Fig. 1. At the center of the device is a double-pole, double-throw switch, whose poles aa' , bb' , cc' , are mercury wells mounted on Pyrex glass tubes on the three sides of a 45° right triangle. The poles cc' are joined to the terminals of the inductor L , and either one of them may be grounded by a link joining it to the symmetrically situated mercury well d . The poles aa' , bb' , are equipped with exactly similar pairs of leads joining them to the terminals of the two condensers. The latter rest on insulating platforms of adjustable height. A single conducting turn, M , with a thermogalvanometer in series with it is coupled to the inductor to indicate resonance. This is used only for capacity comparison. In making comparisons of effective resistance, it is necessary to actually compare the values of current in the circuit corresponding to different values of inserted resistance. For this purpose a thermoelement with leads to a wall galvanometer is introduced directly in the circuit. This combination forms as current-square meter, the deflection of the galvanometer being, to within the accuracy of most measurements, proportional to the square of the alternating current thru the thermoelement. (As explained in LC 75, readings proportional to the current squared can be used as satisfactorily as values of the current squared itself.) The whole set is mounted on a traveling table.

The use of this set will be assumed in the following description of the method. The reader will have no difficulty in transferring the description to any device which he may wish to use. The procedure is as follows. The test condenser is put on one of the adjustable platforms, the platform is brought to the proper height, and the condenser terminals are joined to the extensions from the mercury wells on that side of the circuit. The standard condenser is similarly connected on the other side of the circuit. The choice of a coil to furnish the inductance for the circuit is determined by the frequency at which standardization is desired. This will be referred to later. The test condenser, if it be variable,

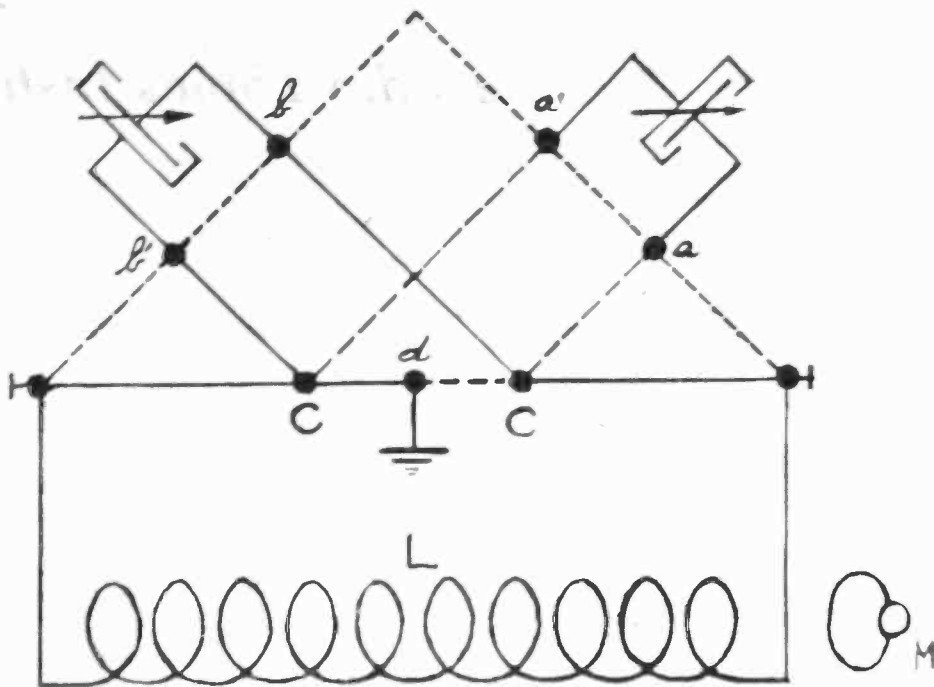

This shows the method of connecting for making comparison tests on variable condensers.

is set at one of the points at which standardization is desired. The points on the scale already cited as suitable for the calibration of a wave meter are equally suitable for the calibration of a condenser. The links are set so as to throw the test condenser in the circuit with either or neither terminal grounded as may be required. The generator is tuned to circuit just formed and the resonant circuit is retuned to the generator, as explained in the description of the calibration of wave meters. If the test condenser is fixed, this step will have to be dispensed with. There need be no danger of an error introduced by failure to take this precaution, however, for several capacity comparisons may be made at different frequencies. Any serious discrepancy among the values obtained caused by a change in the output of the generator will at once be evident and minor variations so caused will be likely to compensate for one another.

The links are now changed so as to throw the standard condenser in the circuit and to ground the proper terminal. This circuit is now tuned to resonance and the condenser setting is recorded. The capacity of the standard at this setting is found from its calibration and since the symmetrical construction of the set makes the circuits formed by the different

positions of the links practically identical, except as to condensers, this capacity will be the capacity of the test condenser at the chosen setting.

After one complete run, that is, one capacity determination at each chosen point of the calibration, the test and standard condensers are interchanged and a second run is made. It is well to use more than one standard if more than one is available, getting values at part or all of the chosen settings of the test condenser in terms of the calibrations of two different standards. This is in compliance with the general principle that, so far as possible, no standardization should depend wholly on any one standard. Corresponding readings of the two runs should, in testing a good condenser, agree within one or two-tenths of one per cent of maximum capacity. Condensers not so good will show greater discrepancies, and it will be found that some condensers will not retain their calibrations to any valuable degree of accuracy whatever. Some of the more common causes of such changeableness are: Bad contact at the bearings, vertical play of the movable plates, looseness of the movable plates so that in turning they are carried out of alignment by inertia, stops against which the mov-

(Continued on page 34)

Some very good ideas and clever suggestions may be secured from these

Recent Radio Patents

VARIABLE CONDENSER

(Patent No. 1,433,224. Issued to John Parkin, Jr., of San Rafael, Cal. Patented October 24, 1922.)

This invention relates to devices for varying the capacity in an electric circuit.

Owing to the large number of persons engaged in experiments in electric arts, especially in radio signaling, there is a great demand for a variable capacity device which is of rugged, simple construction and capable of being made and sold at a very low price. One of the objects of my invention, therefore, is to provide a variable condenser to supply this demand, and in which the elements are reduced to the least possible number and are of the greatest possible simplicity.

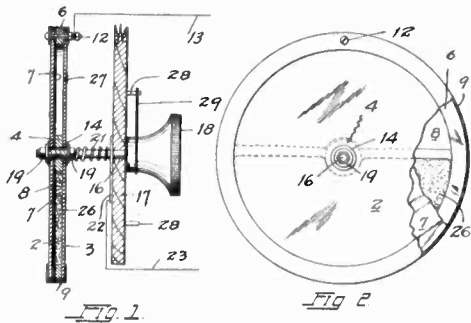

Another object of the invention is to provide a variable condenser of balanced construction and one which is not easily damaged by rough handling. Another object is to provide a condenser of large capacity for its size.

The invention possesses other objects and features of advantage, some of which, with the foregoing, will be set forth in the following description of the preferred form of my invention, which is illustrated in the drawings accompanying and forming part of the specification. It is to be understood that I do not limit myself to the showing made by the said drawings and description, as I may adopt variations of the preferred form within the scope of my invention as set forth in the claims.

Referring to the drawings:

Figure 1 is a vertical section through the center of my variable condenser. The condenser is shown mounted upon a panel, the parts being in the position of maximum capacity. Figure 2 is a rear elevation of the variable condenser, the parts being in the position of minimum capacity. Figures 3 and 4 are vertical sectional views showing modified forms of my device.

My variable condenser comprises two housing disks, 2 and 3, of non-conducting material spaced apart at the center and periphery by the annular rings 4 and 6 respectively. The center spacing ring is of conducting and the peripheral spacing ring of non-conducting material. A dielectric, preferably a thin disk (7) of mica, lies between the annular spacing ring and the disk (2) and a semi-circular metallic plate (8), preferably of foil, is interposed between the disks 2 and 7. The foil, which preferably is adhesively united to the dielectric disk, extends outwardly and is turned about the periphery of the disk (2) so as to establish electrical contact with the annular metallic flanged rim (9), which binds the peripheral edges of the housing disks. A binding post (12) passing through the rim provides means for attaching the conductor (13), comprising one side of an electric circuit. Instead of using a separate plate (8) adhesively united to the disk (7), I may deposit on a portion of the dielectric disk a metallic coating, thus bringing the metal into the closest possible contact therewith.

Passed through the center of the device and securing the parts firmly together at that point is a metallic grommet or eye (14) which is in electrical contact with the annular ring (4).

The device is mounted on a shaft (16) journaled in the panel (17), and digitally controlled by a knob (18) in which the outer end of the shaft is embedded. The other end of the shaft passes through the grommet (14)

and is fixed therein by nuts (19) on each side. A spring (21) on the shaft is interposed between the nut (19) and the solder plate (22) lying against the panel and through which the shaft passes. A conductor (23) comprising the other end of the circuit on which the condenser is used, is connected to the solder plate. The spring thus resiliently presses the knob against the panel and insures an electrical connection between the plate (22) and the annular ring (4).

From the above it will be clear that the foil plate (8) constitutes one of the condenser plates, the other condenser plate comprising a body of mercury (26) confined in the chamber between the dielectric disk (7) and the housing disk (3). The mercury is introduced into the chamber through an aperture in the disks subsequently closed by the plug (27), and the chamber is filled about half full so that the mercury is always in electrical contact with the annular ring (4).

Since the weight of the mercury causes it to always remain in the lower half of the chamber, that is, in substantially fixed or stationary position, it follows that by rotation of the device, by manipulation of the knob, the semi-circular condenser plate (8) may be brought into full or partial registration with the fixed semi-circular condenser plate (26), or placed completely out of registration therewith, varying the capacity of the condenser in accordance with the areas in register. Stop pins (28) on the panel engaged by the arm (29) fixed on the knob, provide means for limiting the rotary movement of the device between points of maximum and minimum capacity.

VACUUM-TUBE CIRCUITS

Patent No. 1,426,735. Issued to Robert C. Mathes of New York, N. Y., and Harry H. Read of East Orange, N. J., Assignors to Western Electric Company, Incorporated, of New York, N. Y., a Corporation of New York. Patented August 22, 1922.)

This invention relates to vacuum tube circuits, and more particularly to multistage amplifier circuits in which the vacuum tubes are employed in the various stages.

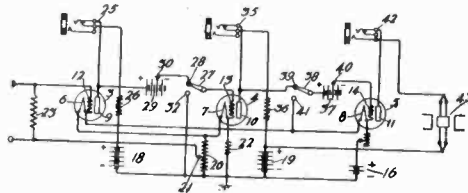

It is well known in the art that a vacuum tube of the three electrode type, for example, will reproduce in amplified form in its output circuit impulses impressed upon its input terminals, and that the amplified impulses may be impressed on the input terminals of other tubes to give any desired degree of amplification. When such a multistage amplifier is employed to amplify low frequency impulses it is generally preferable to have a direct coupling instead of an inductive coupling between stages in order that the low frequency impulses will be accurately reproduced by the amplifiers. But when such a direct coupling is employed considerable difficulty is experienced when signals are being received from preventing the output current of one tube from so affecting the potential applied to the control electrode of a second tube that the second tube is either blocked or has its amplifying action destroyed on account of its control electrode becoming too positive or too negative. In accordance with this invention, it has been found that the operation of such a multistage amplifier set is considerably improved by providing adjustable sources of potential for the control electrodes of the tubes, and by providing switching means between the stages whereby the output current of each tube may be given its proper value by adjusting the normal source of potential for its control electrode independently of this influence of the output current of the preceding tube. This invention will be more fully understood by reference to the following detailed

description taken in connection with the accompanying drawing, which shows one embodiment of this invention in connection with a three stage amplifier set.

Referring to the drawing, 3, 4 and 5 are vacuum tube amplifiers having filaments 6, 7 and 8, anodes 9, 10 and 11 and control electrodes 12, 13 and 14 respectively. Each of these filaments may have a resistance of the order of 4 ohms; 16 is a course of heating current for the filaments, and it is to be noted that starting with the positive pole of the battery 16, the heating current goes through the filament 8, 6 and 7 in the order named. Output circuit current for tube 3 is supplied from battery 18, while the output circuits of tubes 4 and 5 are supplied from battery 19. A source of potential for the grid 12 is secured by the IR drop in that part of resistance 20 which is included in circuit between the grid and the filament 6. An adjustable contact 21 is provided for varying the amount of the potential applied to the grid. This resistance 20 which in one case had a value of 170 ohms, is in the heating circuit for the filaments and is in shunt to filament 7 and a small resistance 22, the function of which will be described later.

ELECTRON-DISCHARGE DEVICE

(Patent No. 1,432,867. Issued to Mervin J. Kelly of New York, N. Y., Assignor to Western Electric Company, Incorporated, of New York, N. Y., a Corporation of New York. Patented October 24, 1922.)

This invention relates to electron discharge devices and to a method of manufacturing them.

One object of the invention is to increase the amount of power which may be applied to an electron discharge device while still keeping within the safe limits of temperature under which the electrodes can function.

Another object is the elimination of the objectionable effect which is sometimes produced in electron discharge devices, namely, "blocking," which is caused partly, at least, by undesirable secondary emission from the grid.

Still another object is to eliminate the effects upon the operation of electron discharge

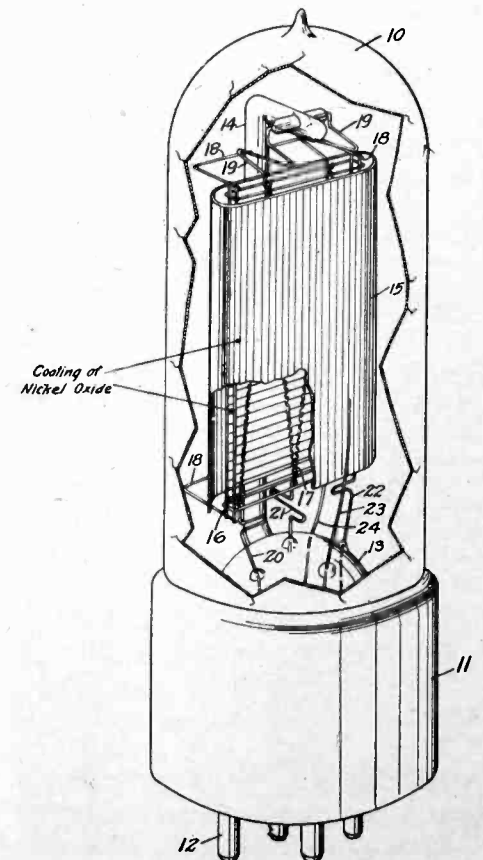

devices which the lodgement of particles of the filament coating upon the grid have caused.

One feature of my invention comprises the provision of a black coating on the electrodes of electron discharge devices, particularly the plate and grid. In a preferred form of my invention using electrodes composed of nickel, a coating of oxide of nickel is produced on the surface by oxidation at a suitable temperature, preferably about 900° C. in an electric furnace in the presence of air. Using other metals for electrodes, such as molybdenum, other suitable black coatings may be formed within the spirit of my invention.

Electron discharge devices have been deficient in their operation in one respect because only a limited amount of power could be handled by them without heating the electrodes beyond a safe temperature. By increasing the capacity of the electrodes to radiate heat faster, we can increase the power applied and still keep the temperature within safe limits.

Furthermore, electron discharge devices, particularly when considerable amounts of power are handled, have been subject to a "blocking" phenomenon which has paralyzed the tube operation. When strong electron currents are passing the bombardment of the grid sometimes produces a secondary emission from the grid, the flow of which secondary current is opposed in direction to the normal operating electron or space current. In some cases this secondary has completely neutralized the normal current and thus "blocked" the proper functioning of the device.

A second feature of my invention involves the coating of the grid or control electrode with a substance which acts to substantially eliminate electron emission therefrom. It has been found that nickel oxide, or molybdenum oxide on the grid surface produce this result. Other substances which are semi-insulating in their properties may be used. It is not here necessary to develop the theory as to why such a coating on the grid reduces the electron emission therefrom and is sufficient to state that these coatings do so reduce it.

My invention is illustrated in the drawing which shows a form of device to which my invention is applied.

VACUUM-TUBE SOCKET

(Patent No. 1,432,992. Issued to John O. Gargan of Brooklyn, N. Y., Assignor to Western Electric Company, incorporated, of New York, N. Y., a Corporation of New York. Patented October 24, 1922.)

This invention relates to socket structures, and has for its object the provision of a socket in which spare vacuum tubes used in telegraph sets may be carried without undue vibration or liability to breakage.

In telegraph sending and receiving sets, particularly of the portable type, adapted to be used in field work, it is often advisable to

carry spare tubes. Due to the rough usage to which these sets are often subject, it is necessary to provide a holder for them, of such construction that the tube shall not readily fall out.

The invention comprises a socket into which the tube is inserted and to which it is locked by a bayonet slot construction acting in combination with a resilient means at the base of the socket, which operates on the base of the tube to hold it in place.

The invention is illustrated in the drawing of which Fig. 1 is an elevation of the tube and socket with a portion of the base broken away, and showing the device attached to a portion of a portable telegraph set, and Fig. 2 is a plan view looking downward upon the device with the tube removed from the socket.

As shown in the drawing, the socket is adapted to be attached to a suitable portion, preferably the inside of the cover (1) of a portable telegraph set, and is mounted on a base (2), which is fastened in any suitable manner to the cover (1). This base comprises a somewhat U-shaped member, having at each end offset portions (3) which extend in a direction parallel to the surface of the cover to which it is attached. Two rather thick strips of rubber (4), or other suitable resilient material, extend across the U-shaped depression in the base (2), from one portion (3) to the other portion (3) at opposite ends of said portions (3). These rubber strips are, at each end, fastened to the portions (3) of base (2) by means of suitable screws (5). A vacuum tube socket (6) is supported from the rubber strips (4) by means of a plate (7) per-

Fig. 2.

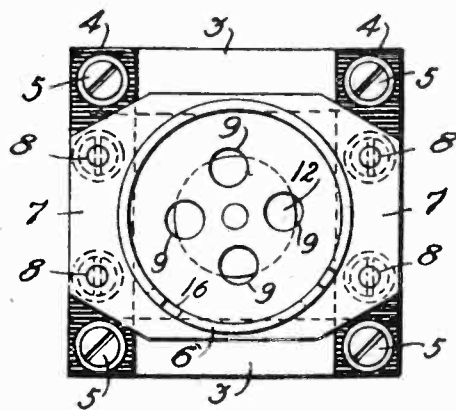

manently connected to the socket and forming a part of the bottom wall thereof, which plate is attached to the rubber strips by means of the screws (8). In the bottom wall of the socket (6) and the plate (7) are a plurality of aligned apertures (9) through which are adapted to extend the electrodes (10) of a vacuum tube inserted in the socket. A stud (11) is rigidly mounted in the center of plate (7) of the bottom wall of the socket and centrally with respect to said apertures (9) and extends downwardly from the bottom of the socket into the U-shaped portion of bracket (2). A disk (12) is positioned against the bottom of plate (7), and has an aperture therein surrounding stud (11). This disk is of such diameter as to substantially cover the apertures (9) in the bottom wall of the socket and is normally held against the bottom of plate (7) by means of a spring (13) which extends between disk (12) and a washer (18), held on to stud (11) by a pin (14) at the outer end of stud (11).

The device which is shown in the form of a vacuum tube of any suitable construction is preferably provided with a base portion (15) having at its lower end a plurality of electrodes (10) which are so arranged that, when the tube is inserted in the socket (6), the electrodes will extend through the apertures. A slot (16) is provided in the side of socket (6), which is adapted to co-operate with a pin (17) on the plug of the tube or lamp to form a bayonet lock.

CONNECTION FOR ELECTRICAL APPARATUS

(Patent No. 1,422,429. Issued to Charles D. Filkins of Schenectady, New York, Assignor to General Electric Company, a Corporation of New York. Patented July 11, 1922.) My present invention relates to connections for electrical apparatus, and more particularly to an improved means for making an electrical connection to a movable element in an electrical device.

The object of my invention is to provide a simple, efficient and reliable means for providing an electrical connection to a movable element in an electrical device which will allow any desired freedom of movement of the movable element without interfering with the flow of current to the movable element.

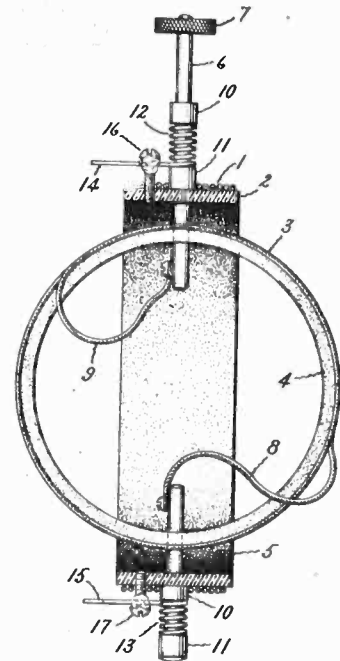

In the construction of variable coupling devices or variometers for use in radio circuits it has been customary to provide a fixed coil and a movable coil, which is adapted to rotate with respect to the fixed coil in such a way that the coupling between the two coils may be varied by rotating the movable coil between a position where its plane is parallel with that of the fixed coil and a position where its plane is at right angles to that of the fixed coil. It has been customary in such devices to make electrical connections to the movable coil by means of flexible leads brought from the terminals of the movable coil to fixed terminals located at some convenient place on the apparatus. This method has the disadvantage that it is not possible to rotate the movable coil continuously in one direction, and since the leads are usually located out of sight of the operator there is the danger that the operator will attempt to rotate the coil too far in one direction and break the leads. The leads are also apt to be broken by the continual bending which is incident to the normal operation of the device.

A more specific object of my invention is to provide a method of making the connections to the movable coil of a variometer, which will overcome the above-mentioned disadvantages. Still another object of my invention is to provide a means for holding the movable coil in a desired position and prevent it from moving when the apparatus is subjected to shocks or vibration.

In carrying my invention into effect the movable coil is mounted on a pair of trunnions which pass through the support on which the fixed coil is wound and have bearings in this support. The terminals of the movable coil are connected to these trunnions. A pair of collars is provided upon each trunnion and helical spring conductors are provided which surround the trunnions and are held in compression by the collars. In this way an efficient fractional engagement is secured between the trunnions and the spring conductors, and the ends of these spring conductors are secured to fixed terminals whereby circuit connections may be made to the movable coil. This frictional engagement of the helical spring conductors with the trunnions also serves to prevent the movable coil from rotating except when it is turned by the operating handle which is secured to one of the trunnions. The novel features which I believe to be characteristic of my invention are set forth with particularity in the appended claims. The invention itself, however, both as to its organization and method of operation will best be understood by reference to the following description taken in connection with the accompanying drawing, in which I have illustrated one way in which my invention may be carried into effect.

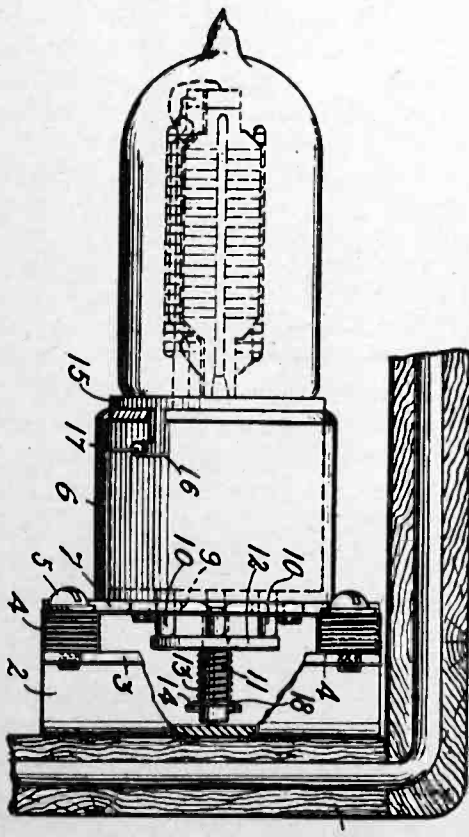

RADIO TOPICS

The National Radio Monthly



FOUNDED 1921

PUBLISHED EVERY MONTH BY
RADIO TOPICS, Publishers
 1112 North Blvd.
 OAK PARK, ILLINOIS, U. S. A.
 NORMAN E. WUNDERLICH, EDITOR

PUBLISHING AND EDITORIAL OFFICES Chicago Fone: Austin 9300 Oak Park Fone: Oak Park 3200	CHICAGO ADVERTISING OFFICES ONLY 1032 Tribune Bldg. Chicago Fone: 5134
--	---

Twenty Cents the Copy From All Newsdealers. By Subscription: To the United States and Possessions, Cuba and Mexico, \$2.00 the Year. Remit by U. S. Money Order, Express Money Order, Check or by Draft, payable in U. S. Funds.
 To Canada—By Subscription, \$3.00 the Year. Single Copies 25 cents—Canadian or U. S. Funds.

RADIO TOPICS is on sale the 10th of preceding month. Manuscript and advertising forms close the 22nd of second month preceding issue.

OAK PARK, ILL., JANUARY, 1923

The subscription and general circulation of the radio publication formerly known as Radio Instructor has been taken over by Radio Topics, copies of which will be sent to subscribers of the former magazine until their termination.

NEW RADIO LEGISLATION

A CONFERENCE was held last February in Washington with the idea of working out new radio regulations to amend the laws of 1912 which really do not regulate the present radio situation one bit.

The conference consisted of a number of the prominent radiomen of the industry and government departments. After considerable wrangling they succeeded in drawing up a proposed amendment which was then to be introduced into Congress by Congressman White, and the amendment became known as the White Bill.

The amendment, as it was presented in the White Bill, empowered the United States Secretary of Commerce, together with a representative body of twelve men, to decide just what laws are necessary and put them into force.

Although this plan did not meet with the unqualified approval of everyone concerned, it was such a great step forward that the majority hoped to have it passed through and let the details take care of themselves as time required.

So far, so good, but that was the last thing that we, or anyone outside of Washington, heard of the White Bill.

A few weeks ago Mr. Paul Godley was accidentally detained in Washington and he decided to find out how things stood. To his utmost dismay he finds that Mr. White has forgotten all about the bill, and the other

government people concerned are also "laying off." "Why?" he asks, and they tell him that nobody seemed to know what they want and they had presumed that the best thing to do would be to let the radio people stew in their own juice until they all agreed to get behind one definite plan.

And this is the way things stand right now. It is sorrowful to think that after all the time and work that was put in by the men at that conference that nothing should materialize.

The entire situation comes down to this: the laws of 1912 are worthless and new regulations must be put into force. Although the White Bill has some questionable points, it presents the only way in which the necessary new regulations can be secured quickly.

There is now a short session of Congress being held which will adjourn in March. Unless the White Bill is forced before Congress at this short session we will not be able to have any new regulations before 1925. But we must have them, and it must be long before 1925. The exact status and operating conditions for both amateur and broadcasting stations will have to be decided within this year if a disaster is to be averted.

Last month a meeting was held by editors of radio publications, writers and manufacturers as well as amateurs in New York. The situation was gone into very thoroughly and it was agreed that immediate force must be exerted to have the White Bill brought up before Congress at the present short session. An experienced committee of publicity men has already started to work and it remains for our readers to give the movement the necessary momentum to push it through. Sit down now and write an urgent letter to your own congressman and also to Congressman White requesting that the White Bill be brought before Congress right away.

ANOTHER NEW YEAR

The time for the usual New Year resolutions will soon be with us and it is sincerely hoped that everyone will resolve, among their many other resolutions, to make 1923 a better and more prosperous year for radio.

During the past year we have gone through the regular cycle of changes which come about in every new development which interests, as radio does, the entire citizenship of the country. We have had the sudden flare-up of interest, then the lull, and now the reconstruction and stabilizing of details.

Let us hope that there will be a solution to the amateur and broadcasting troubles. There can and will be logical solutions to most of the troubles which we are now encountering. Troublesome interference will be overcome and broadcasting programs will be improved. Organized efforts and fair play in hand with Old Man Time are sure to accomplish every improvement which we desire.

To every reader and advertiser of ours and to the others associated in this field of radio communication we earnestly hope that their happiness in the New Year will be as great as is our gratitude for the splendid co-operation that we have received in the year gone by.

Correspondence With the Institute

THE RADIO TOPICS INSTITUTE, since its introduction a number of months ago, has received numerous inquiries. As they will prove interesting, they will appear monthly under this department.

RADIO TOPICS INSTITUTE,
Oak Park, Ill.

I am interested in making a radio receiving set as described on page 30 of your October issue. What would be the charges for copy of wiring diagram and general information in simple language?

H. J. MAITHIS,
Verona, Ky.

There was never any charge for such material. We are glad to send you the diagrams under separate cover. General construction details are contained in the article referred to.—Institute Director.

RADIO TOPICS INSTITUTE,
Oak Park, Ill.

I am a constant reader of your interesting publication. I have been using a single circuit regenerative set with two steps of audio amplification, but recently became interested in radio frequency amplification. Referring to Fig. 6 on page 30 of your December issue, a radio frequency circuit wherein four tubes are supposed to do the work of six.

First, I have an outdoor aerial which I consider excellent and would not wish to change if it can be used with this hook-up. An ordinary variocoupler tapped, with a secondary condenser would do the trick, I suppose, but would like your confirmation of this. Will this layout work a loudspeaker, "Dictagraph"; if not can audio frequency amplification be added? What voltage "B" battery is necessary and should first r. f. transformer be tapped at 22.5 volts and could home-made r. f. transformers be used with satisfaction, for instance, one with a 1½ inch core with No. 38 or No. 40 wire? If you will supply me with this information I will be glad to pay any expense that may be incurred.

C. L. WEATHENOAX, Jr.
4819 Hammett Pl.,
St. Louis, Mo.

The use of an ordinary variocoupler with your regular outdoor aerial and with a variable condenser across the secondary will work very

well in connection with this Latour circuit. Home-made transformers may possibly answer the purpose, but this can best be found out by experimenting. This set, when being tested by our laboratory, operated a Western Electric loud speaker with entire satisfaction, and no doubt will work your Dictagraph speaker. The addition of further audio amplification can be made from the points where the phones are connected, although it is best to add a power amplifying unit.

The "B" battery voltage is dependent upon the tubes employed. Sixty to one hundred volts were used by us. A most peculiar thing of this set is the fact that the detector tube may be entirely removed after a station has been tuned in and the signal strength will be increased. A complete article on the detailed construction of this set is now being prepared and will be presented in an early issue.—Institute Director.

RADIO TOPICS INSTITUTE,
Oak Park, Ill.

I would appreciate your opinion regarding the "construction sets" put out by the Sleeper Radio Corporation. I wish to know whether or not their sets are of approved design and really worth while. I write particularly of their regenerative receiver type 2600, which they describe as a really universal outfit made up of a long-range tuning control, variometer for tuning the plate circuit, with a detector and two stage amplifier. For this they ask \$47.12, not including, of course, batteries, bulbs and other accessories. The price seems low enough if the receiver is what they claim.

I intend to install a set on a ranch in New Mexico near Las Vegas this winter. Would the above set answer the purpose, that is, would we be able to hear any eastern stations. Thanking you, I am yours truly,
RICHARD MOORE, Jr.,
4421 Westminster Place,
St. Louis, Mo.

The apparatus designed by the Sleeper Radio Corporation is highly recommended. Mr. Sleeper is a

high grade radio engineer, and we are pleased to advise our readers that he will soon write more of his splendid radio construction articles for RADIO TOPICS. We are sure that you will find their sets all that they claim.

Las Vegas is nicely located on the east side of the mountain range nearby, so little difficulty should be encountered in hearing eastern stations. WSB at Atlanta, Ga., is 1,200 miles to the east and will be heard regularly. You should hear Chicago, 1,000, and Davenport, Kansas City, Des Moines and others as close as 500 miles should be heard consistently, if a good antenna and ground are used. Climatic conditions in New Mexico are not always the best, and sometimes it may be impossible to hear anything. Unless you have done considerable experimenting with radio-frequency amplification and are well versed in its many peculiar characteristics, we feel certain that a good regenerative receiver with two steps of audio amplification will be the best.—Institute Director.

RADIO TOPICS INSTITUTE,
Oak Park, Ill.

I am interested in radio to the extent that I have made several crystal detector sets and would now like to have the plans for building something better. Could your institute furnish me with the desired instructions or advise where they may be secured?

O. E. HASSLER,
324 50th St.,
Fairfield, Alabama.

You will find published elsewhere in this issue an article on the construction of an efficient, inexpensive short-wave regenerative receiver which was prepared by our institute.—Institute Director.

RADIO TOPICS INSTITUTE,
Oak Park, Ill.

Kindly send me a hook-up for two stages of radio frequency amplification to be added to my short wave regenerative receiving set.

F. J. PRYHUBER,
Chicago, Ill.

It is not possible to do this without changing the entire set and parts. A number of circuits were given in the December issue.—Institute Director.

American RADIO Exposition

The Official Exposition
for American Man-
ufacturers

with the endorsement of the

NATIONAL RADIO
CHAMBER OF
COMMERCE

and sanction of the Radio
Apparatus Section of the

ASSOCIATED
MANUFACTURERS of
ELECTRICAL SUPPLIES

Grand Central Palace
New York

December 21st to 30th

(Sunday excepted, but Christ-
mas Day included)

This first really compre-
hensive Exposition is to
be staged in a manner
worthy of a great in-
dustry.

The leading manufac-
turers have contracted
for space, and many
more are at present
negotiating for repre-
sentation. This oppor-
tunity to display Radio
products to thousands
of buyers during the hol-
iday season is an unu-
sual one. The exposi-
tion will be one of New
York's big features in
connection with Nation-
al Radio Week.

For further particulars
write or wire

AMERICAN RADIO
EXPOSITION
COMPANY

120 Broadway, New York
Telephone John 0009

THE TEST AND STANDARDIZATION OF CONDENSERS AT RADIO FREQUENCIES

(Continued from page 29)

able plates strike and are jarred out of alignment, a loose scale or index which slips on the rotating shaft.

Since the capacity of any but the best condensers varies with frequency, it is necessary to know at least approximately at what frequency the comparison is made. This may be determined by a wave meter if one is available, or, if the value of inductance used is known, it may be calculated from the relation.

$$f = \frac{159.15 \times 10^3}{\sqrt{LC}}$$

where f is the frequency in kilocycles per second, L is the inductance in microhenries, and C is the capacity in micromicrofarads. The corresponding relation for the wave length is

$$\lambda = 1.884 \sqrt{LC},$$

where λ is the wave length in meters.

The choice of a value of inductance for the circuit is determined by the frequency at which it is desired to know the capacity of the condenser. If measurement is desired at a specific frequency, a variable inductor may be used. But a variable inductor is not a satisfactory element of a measuring circuit as compared with a well designed fixed inductor. A better way, at least in testing a condenser whose capacity does not change greatly with frequency, is to choose two fixed inductors having inductances of such values that the circuits which they form with the condenser under test have natural frequencies respectively a little greater than and a little less than the frequency at which the capacity is to be determined. Capacity measurements made with these two inductors in the circuit will generally agree within the error of measurement, or, failing in this, will agree so closely that linear interpolation between the two values obtained will be justified.

To measure the effective resistance of a condenser, a thermoelement with leads to a wall galvanometer is introduced in the circuit, as already mentioned. The resistance of the circuit with the condenser under test inserted is measured by the resistance-variation method described in LC 75.

If one side of the circuit is grounded, the resistors used are inserted on the grounded side. The switch is then thrown to insert the standard condenser in the circuit, and the resistance is again measured. If the standard condenser is of the type described at the beginning of this article having negligible resistance the difference between the resistance of the circuit with the condenser under test inserted and the resistance with the standard inserted is the resistance of the condenser under test at the frequency at which the measurement is made. If the resistance of the standard is not negligible but is known for that frequency, the resistance of the condenser under test will be the difference mentioned, with the proper algebraic sign, plus the resistance of the standard at that frequency.

The resistance of a well designed condenser is apt to be so small in comparison with that of the circuit that an accurate determination will not be possible.

The use of Pyrex glass as insulator and mercury at the contacts in the switch is chiefly for the purpose of keeping negligible the resistance of that small part of the circuit outside the condensers which is changed by shifting the links, and thus avoiding the introduction at one position of the switch, of any resistance, other than that of the condensers, which is not present at the other position. In addition to precautions of this kind, however, the measurements should be repeated with the two condensers interchanged on the two platforms.

The advantage of a well designed fixed inductor over a variable inductor is particularly marked in the comparison of two condensers as to resistance, since the resistance of the fixed inductor will generally be much lower than that of the variable, and the condenser resistance much more appreciable as a consequence. On the other hand, there is much less likelihood than in the capacity measurements that linear interpolation will be justified between determinations at frequencies near to that at which it is desired to know the resistance.

The phase difference is derived



“We are now signing off—Good Night”

Now Attach **THE HOMCHARGER**

To your AC lamp socket, snap the clips on your storage battery and “turn in.”

While you sleep, the RADIO HOMCHARGER DE LUXE is silently charging your battery—the charging rate being governed automatically. In the morning it is fully charged; ready for another evening’s entertainment, and the cost has been less than a nickel for current consumed.

No muss, trouble, dirt—no moving of battery—loss of time. You can’t connect it up wrong—it can’t overcharge nor harm your battery in any way. Its beautiful mahogany and gold finish will harmonize with any living room.

Furnished complete with Ammeter, Attachment Cord and Plug, Charging Cable and Battery Clips, by all good dealers handling radio and electrical equipment, for \$18.50.

Ask your dealer for Bulletin No. 637, illustrating the new HOMCHARGER in actual colors, or write direct.

CAUTION When buying a Rectifier insist upon the following:

- 1—SELF-POLARIZING feature, otherwise your battery may be ruined through reverse charging.
 - 2—AT LEAST FIVE AMPERE CHARGING RATE, otherwise it will require several days to fully charge your battery.
 - 3—UNDERWRITERS’ APPROVAL, otherwise in case of fire your insurance may be void.
- The HOMCHARGER is the only Rectifier at any price which combines the above, three NECESSARY HOMCHARGING features.

THE AUTOMATIC ELECTRIC DEVICES COMPANY

137 WEST THIRD STREET, CINCINNATI, OHIO

HOWARD
MICROMETER ADJUSTMENT RHEOSTAT

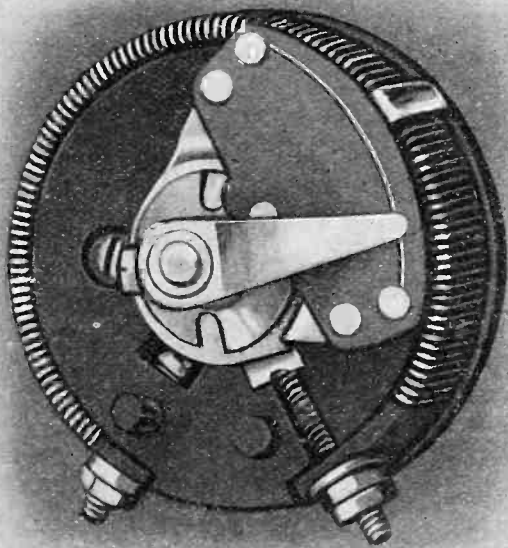

PATENT PENDING

A Micrometer Rheostat

As implied by the name, this new Rheostat is provided with a POSITIVE and EXTREMELY SENSITIVE CONTROL.

By its use “gas tubes” may be operated at the peak of the receiving efficiency.

The desired control is obtained by turning the SINGLE KNOB through less than ONE complete turn.

THINK OF IT! ANY FRACTION of the resistance contained in a wire EIGHTY INCHES LONG may be inserted in the circuit by operating the SINGLE KNOB through LESS THAN A COMPLETE TURN.

Also, duplicate settings can be made at any time, without difficulty.

SPECIFICATIONS

- Resistance—zero to approximately seven ohms.
- Current carrying capacity 1½ amperes.
- Temperature co-efficient practically zero.
- Base and knob—special heat resisting composition.

PRICE \$1.50

Price including special dial described below, \$1.75.

MICROMETER ATTACHMENT (Patent Pending). The micrometer attachment described in connection with the above rheostat has been so designed that it can be placed on any regular Howard rheostat in about one minute’s time. Price for attachment only 50 cents.

Special MICROMETER RHEOSTAT DIAL (Patent Pending). We manufacture a special dial for use with micrometer rheostat and attachments described above.

The dial differs from any other rheostat dial on the market. It indicates the position of the contact blades and therefore duplicate settings on the main as well as the micrometer portions of the rheostat are easily made. The dial is graduated in ohms and fractions of ohms. Price, dial only, 25 cents. Ask your dealer to show you samples.

MANUFACTURED BY

HOWARD RADIO COMPANY

Liberal Discounts to the Electrical and Jobbing Trade

4248 North Western Ave.
CHICAGO, ILL., U. S. A.

The Future of RADIO



The fun and entertainment you and your friends get from Radio should never be marred by failure of your apparatus to do its part—and it won't fail if it is properly made.

The Radio "fans" of today will be the Radio experts of the future—PROVIDED the equipment used NOW gives service and satisfaction.

Every SIGNAL item is made in a factory that has grown up with "wireless," and therefore guarantees Radio Parts and Radio Sets that are RIGHT, and are dependable. To be sure you can listen in with SATISFACTION, say SIGNAL and stick to it, when you buy Radio equipment.



Signal Junior Detector Units

Each unit complete. Combine two or more, adding power and range as each unit is added.

SIGNAL Electric Mfg. Co.

Factory and General Office
1901 Broadway, Menominee, Mich.
Atlanta, Boston, Cleveland, Chicago, Minneapolis, Montreal, New York, Pittsburgh, St. Louis, San Francisco, Toronto.

You'll find our local address in your Telephone Directory.

COUPON FOR GUIDE TO RADIO SATISFACTION.

Please send, without obligation, your interesting book about SIGNAL parts and sets, to the name and address written in the margin of this page.

1922-A

Yours for the asking

a free copy of "Chi-Rad's" 1923 loose leaf catalog. Inasmuch as "Chi-Rad" is a distributor for practically all of the leading radio manufacturers, this catalog will be a convenient and comprehensive review of most of the noteworthy radio parts of recent manufacturers.

Mail the coupon below now to be sure that you get your copy. Because of constant improvements and price changes in radio parts, only a limited number of catalogs have been printed.

DEALERS:
Ask for special discount sheet

101

Gentlemen: Please send me, without obligation, a free copy of your 1923 catalog.

Name.....

Address.....

City..... State.....

Chicago Radio Apparatus Co.

415 South Dearborn Street,
Chicago, Illinois

States Radio Corporation

Manufacturers of



Radio Equipment

501 South Jefferson Street
Chicago, Ill.



NA-ALD

Small Space

V.T. Socket

35c each, 3 for \$1

Moulded genuine condensite. Requires but small space for mounting. Readily accessible binding posts. No excess metal to interfere with efficiency. Unaffected by heat of bulbs or soldering iron. Phosphor bronze contacts. Nickel plated brass binding screws. Slash cut slot. Price possible because of large production.

Special proposition for dealers and jobbers.

Alden-Napier Co.

52 Willow St., Springfield, Mass., Dept. E

from the resistance by means of the relation:

$$\times = 130 \times 10^5 f R C$$

or the equivalent relation:

$$\times = 388 \frac{RC}{\lambda}$$

where \times is the phase difference in seconds, R the resistance in ohms, C the capacity in micro-microfarads, f the frequency in kilocycles per second, and λ the wave length in meters.

The same method and instrument can be used to measure the phase difference and dielectric constant of insulating materials. A condenser having the insulating material under test as its sole dielectric is made as follows: The insulating material in the form of a wide slab is floated in a tray of clean mercury. A loop of square rod slightly smaller in area than the slab is laid on the slab, forming a rim around its edge. The space so enclosed is filled with clean mercury. The condenser formed by the mercury surfaces and the insulating material between them is compared with a standard as to capacity and resistance. The phase difference is obtained from the formula already given and the dielectric constant from the equation:

$$K = \frac{11.3 C d}{S}$$

$$K = \frac{11.3 C d}{S}$$

where K is the dielectric constant, C the capacity in micromicrofarads, d the thickness of the dielectric in centimeters, and S the area of one side of a condenser plate in square centimeters.

ELEMENTARY ELECTRICAL PRINCIPLES

(Continued from page 24)

ing a line? How would you determine the proper size wire to use?

8. Where in your radio transmitting set must you be careful about wire sizes and what will happen if you overlook this?

9. What is the best material used for wires to carry electric current other than silver? Why use this material?

10. What is meant by a circular mil? Where is this term used in electricity?

In the next issue an article will appear taking up a further consideration of the flow of current in conductors. The radio students who are interested in these

(Continued on page 42)

BRISTOL'S AUDIOPHONE

LOUD SPEAKER METHOD of RECEIVING

Makes You Forget It Is Radio-Phone
So Like the Original Voice and Orchestral
Instruments

The tone is big in volume, rich, round and free from mechanical distortion.

The result of over six years' work on "Sound Reproduction" in the laboratories of The Bristol Company, a world known engineering firm, the Audiophone is not a temporary piece of equipment, but a permanent contribution to the Radio Field.

No Auxiliary Batteries are required for magnetizing.

About one Watt is necessary to give the Audiophone full volume.

Most amplifiers are two stage and designed to give good response in head phones, but there is not sufficient power to operate loud speaker, except for small audiences. For this reason it is desirable to provide another stage of power amplification, and Bristol's One Stage Power Amplifier is available, which will give volume enough to be easily heard in a room seating 500 persons and over, when added to one or two stage amplifier.

Our representatives are located in all parts of the country. We can come to you with demonstration. Shall we send bulletins?

THE BRISTOL COMPANY
WATERBURY, CONN.



BRISTOL'S
AUDIOPHONE SR.
Horn 13 Inches Dia.
Price \$40.00

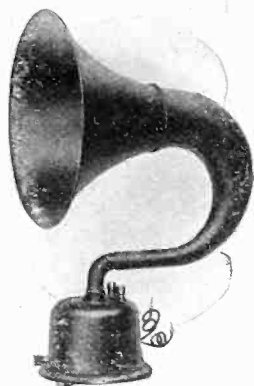

BRISTOL'S
AUDIOPHONE JR.
Horn 11 Inches Dia.
Price \$22.50



BRISTOL'S
ONE STAGE POWER
AMPLIFIER
Price \$25.00

RADIO PANELS

and other insulation for Wireless Work

BAKELITE-DILECTO

Grade XX Black was used by the Government during the war for this purpose. It is the

STANDARD OF THE WORLD

THE CONTINENTAL FIBRE COMPANY
NEWARK, DEL.

New York, 233 Broadway.
Pittsburgh, 301 Fifth Ave.
Los Angeles, 411 S. Main St.

Chicago, 332 S. Michigan Ave.
San Francisco, 75 Fremont St.
Rochester, N. Y., 85 Plymouth Ave. S.
Seattle, Wash., 1927 First Ave. S.

HOW RADIO INCREASED GOOD WILL FOR 9 CONCERNS

(Continued from page 27)



BURGESS RADIO BATTERIES

- ARE RECOMMENDED by leading manufacturers of radio equipment.
- ARE SPECIFIED by radio engineers.
- ARE DESIGNED AND BUILT by radio engineers.
- ARE A GUARANTEE of satisfactory service.
- ASK ANY RADIO ENGINEER.

Burgess No. 6 Batteries

Are highly recommended for use in "A" or filament circuits where Westinghouse WD-11 Vacuum Tubes are used.

Burgess Radio Batteries are handled by all progressive jobbers and dealers. Look for the distinctive black and white stripes. If your dealer doesn't handle the Burgess line just address the nearest Burgess office below.



BURGESS BATTERY CO.

Engineers—Dry Batteries—Manufacturers — Flashlight — Radio — Ignition — Telephone.

General Sales Office:
Harris Trust Bldg., Chicago

Laboratories and Works:
Madison, Wisconsin

Branches:
New York, Boston, Washington,
St. Paul, Kansas City,
New Orleans

In Canada: BURGESS BATTERIES,
Ltd. Winnipeg, Toronto, Montreal

"Ask Any Radio Engineer"

BURGESS

RADIO BATTERIES

The radio organization started in this way has tremendously increased in membership. The receiving outfits are sold by the Cline-Vick Drug Company and their cost is shared proportionately by the members making up any particular unit of the organization. This initial expenditure on the part of the members makes up the initiation fee. Small monthly dues are charged which entitle the members to be present and hear the broadcasting programs and to receive copies of the printed program.

These clubs are generally in a church basement. Church people are glad to get the young men of the town interested in something of this sort. Besides a president and secretary, the organization has a tuner who has charge of the instrument. The clubs purchase a loud-speaking attachment which enables all members to get the benefit of the program at the same time. Small, neat-appearing pins are worn in their coat lapels by the members of the organization, singling them out as "Radio Bugs."

In addition, they publish a small pamphlet entitled "Egyptian Radio Broadcasting News." The plan pays well, for it not only sells receiving outfits, but it also gives the Cline-Vick Drug Company some excellent publicity.

Banks are finding other uses for the radio telephone beside incentive to install radio equipment, in obtaining market reports and quotations. At the same time there is scarcely a doubt but that the publicity value inherent in the installation of the radio telephone is its greatest value so far as banks are concerned.

The Farmers and Merchants Union Bank of Columbus, Wis., was one of the first banks in the State to install radio equipment, according to J. R. Wheeler, president. This bank gives a market service received by radio telephone and the bank is always crowded with farmers waiting for the latest quotations. Of one interesting plan used, Mr. Wheeler says: "When we are able to receive good music from any of the stations, and it is convenient, we turn on an outside light to indicate that the public is welcome, and have frequently had twenty

to twenty-five people in the assembly room listening in. Of course the children are the most interested audience.

"It is possible that the usefulness of the radio telephone is greatly exaggerated, but we do not regret that we installed ours and believe that many country banks will install the radio telephone merely to obtain the daily market reports."

Many banks all over the country are making a similar use of this method of communication. Wisconsin bankers have done a great deal along this line. The Eau Claire Savings Bank and the State Bank of Reedsburg are among those which have radio outfits. The fact that so many Wisconsin bankers are finding radio profitable is largely due to the excellent co-operation afforded by the authorities at the University of Wisconsin and those in the State Department of Markets at Madison.

A LIMITATION ON THE USE OF THE RADIO TELEPHONE.

One hindrance to radio telephone communication as it is developed at present is that it is for the most part a one-way service; it has not the flexibility of the telephone service—it cannot be directed toward one individual, and two-way connection is possible only with expensive apparatus. Despite this, radio is being used extensively in business and its rapid development is marked by many novel features.

Market reports are vital items to the farmer; the Department of Agriculture sends them over the country by radio. It is estimated that fully a sixth of recent installations of receiving sets have been made by farmers for the purpose of receiving these reports.

Another interesting development in the application of the radio telephone to business is the proposal of the American Telephone and Telegraph Company to erect a wireless broadcasting station for commercial purposes on the roof of the Walker-Lispensard Building in New York.

"This station is being established as a commercial experiment to test the demands of the public for a service of this sort," says J. D. Ellsworth of the Amer-

DICTOGRAPH Radio HEADSET

Was \$12.00 **NOW** →

Why This Sensational Reduction In Price?

A sweeping cut of \$4.00 in the price of the Dictograph Radio Headset! The tremendous indorsement of radio enthusiasts has made possible this sensational reduction. To meet the demand, production has been planned on a new, gigantic scale. Great manufacturing economies establish the new price—only \$8.00.

A wonderful bargain! And above all, a wonderful headset—the world's standard of supreme quality for super-sensitive and accurate sound-transmission.

The same quality, the same guarantee, the supreme Dictograph headset in every respect but the price. Type R-1, 3,000 ohms, for all types of receiving sets.



List Price

\$20



DICTOGRAPH Radio LOUD SPEAKER

THE PERFECT LOUD SPEAKER FOR THE HOME

Public demand has made possible the Dictograph Loud Speaker at the low price of only \$20.00, complete with 5 ft. flexible cord. A handsome instrument that reproduces every sound in crystal-clear, natural tones, full volume, and free from distortion or noise. Ask for demonstration at reliable radio dealers. A suggestion: **HERE IS AN IDEAL XMAS GIFT.** Get world-famous DICTOGRAPH quality and still save money.

DEALERS: Order through your jobber or write direct for names of authorized distributors.

The Standard of the World

NOTE: Plans are now under way for the production of the new 4,000 ohms Dictograph SUPER-TONE Headset, the most perfect radio headset that can be made. For the most delicate work, the most exacting requirements. A new standard of super-sensitiveness!

List Price, \$12.00.

Dictograph Products Corporation

(Branches in all principal cities)

220 W. 42d St.

New York, N. Y.

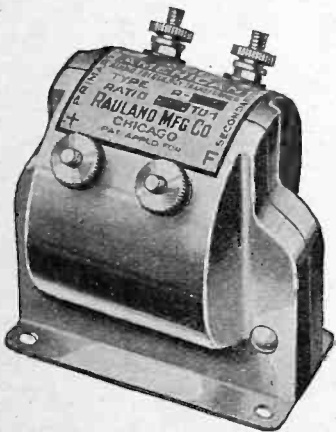

To Strengthen Weak Signals
To Bring-in Distant Stations
To Get the Full Joy of Radio

Scientific *Amplification* is the one secret of successful and satisfactory reception of Radio messages.

You will never know the full joy of Radio until you have hooked up to your set, a set of

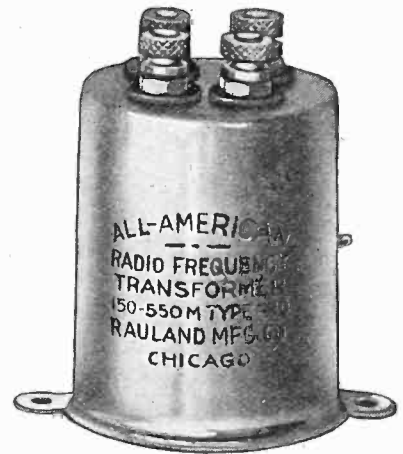

"All American" Amplifying Transformers

(Radio and Audio Frequency)

Our Radio-Frequency Transformer (type R-10) brings in signals of 150 to 550 meter wave-length, and amplifies them many-fold, clear and sharp, largely eliminating static and other disturbances.

Our Audio Frequency Transformers amplify the detected signals, so that messages that would otherwise be audible only thru head-phones come in strong enough to be enjoyed by a roomful of people thru a loud-speaker horn.

LIST PRICES

R-10—Radio Frequency (150-550 meters) \$4.50
R-12—Audio Frequency (Ratio 3 to 1) 4.50

R-13—Audio Frequency (Ratio 10 to 1) \$4.75
R-21—Audio Frequency (Ratio 5 to 1) 4.75

Send for Bulletin No. 22. It explains the technical and mechanical reasons for the splendid performance of "All-American" Amplifying Transformers. When you send for it, please give the

name and address of the Radio Dealer thru whom you prefer to buy. Don't let anybody sell you a Radio outfit at any price, with any other than "All American" Transformers.



RAULAND MFG. CO.
35 So. Dearborn St., Chicago, Ill.



—if you can afford
to pay more—
You will still want
Crosley Efficiency

CROSLY
BETTER—COST LESS

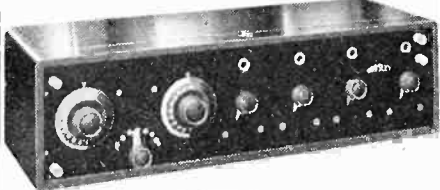

CROSLY RECEIVER MODEL X. This four tube set is the most popular on the market today. It consists of one stage of Tuned Radio Frequency Amplification, Audion Detector, and two stages of Audio Frequency Amplification. The Crosley Model X is built on scientific principles and is the acme of simplicity and efficiency. Especially is the Tuned Radio Frequency Amplification feature popular. It not only serves to magnify the incoming waves before they reach the detector tube, making the signals louder, but eliminates static and interference to a wonderful degree.

With this set listeners in Florida have heard broadcasting from Winnipeg, San Francisco and Honolulu. We cannot be too emphatic in recommending this to everyone. Without phones, batteries or tubes, only \$55.00.

Write for Catalog

Crosley Manufacturing Co.

123 Alfred St. Cincinnati, Ohio



Are You in Doubt

as to what Radio Receiving Set you should get? If so, let us help you select a complete set. We do not sell radio material of any kind. Our method is entirely new. Write for free questionnaire and judge for yourself. Address

RADIO SERVICE SYSTEM

York Bldg., Sheboygan, Wis.

Edeson Radio Phones Adjustable Diaphragm Clearance

We guarantee satisfaction, or your money refunded. The adjustment feature places our phones on a par with the world's greatest makes. Our sales plan eliminates dealer's profits and losses from bad accounts, hence the low price. Better phones cannot be made. Immediate deliveries. Double 3000 Ohm sets, \$3.98; 1500 Ohm single set, \$2.50. Circular free.

Edeson Phone Co. 6 Beach St., Dept. Boston, Mass.



ican Telephone and Telegraph Company. "It is not our plan to send out any program ourselves, but simply to provide facilities for the use of others at reasonable charges. If the demand for broadcasting continues, there will ultimately be no particular advantage in anyone owning a private broadcasting station, and it seems reasonable to suppose that facilities for broadcasting will be provided thru some common agency."

Many requests have been made for such a service, not only from newspapers and entertainment agencies, but also from department stores and a great variety of business houses who wish to utilize this means of distribution. Just as the company leases its long distance wire facilities for the use of newspapers, banks and other concerns, so it will lease its radio telephone facilities and will not itself provide the matter sent out from this station. If sufficient demand for this service develops, similar stations will be erected in various parts of the country.

WHERE RADIO HAS PROVED PRACTICAL AND PROFITABLE TO BUSINESS.

Admittedly radio has filled a niche in some business. The steamship lines are now able to furnish telephone service between their passengers and the land subscriber to the ordinary telephone; this is a case in point. Another is communication to and from moving trains. And the value of radio telephone when power and telephone lines have been damaged and put out of commission is incalculable.

But what of the ordinary business? Has radio a place aside from these special functions? Only the future can tell with certainty.

Without expensive apparatus radio only permits of one-way transmission, and even that, indirect transmission, and in so far as it does this, it can never take the place of the telephone. The proper field of radio is not that of a substitute for wire lines, but rather a supplement thereto. In cases where it is impracticable or impossible to build wire lines, radio may provide the only available communication link.

But in the meantime, does it

pay for business? The experience of the several companies which go to make up this article is decidedly favorable in reply. It has paid and paid royally in profits and increased business. It has been demonstrated beyond reasonable doubt that radio can be made an effective business tool to improve service and to build up good-will and prestige. Just how extensively radio will be used by industry in the future is a moot question, but the present extent of its use in business firms throughout the country indicates that in this aspect radio is here to stay. Each week more names of business firms appear on the federal radio license list. The future undoubtedly will witness many improvements in radio development and with them will come new opportunities for practical usefulness. The past has demonstrated that radio can be applied with profit to business; the future is even more promising. And considering its rapid development, who could ask more?—*Courtesy System.*

A SHORT WAVE GENERATOR RECEIVER

(Continued from page 17)

tion "B," and continuing on with the same wire, start one-half inch over and wind 35 turns in section marked "C," as in Fig. 3. This secondary is tapped at the 1st, 30th and 50th turns.

The tickler coil is wound on the 3-inch tube. Forty turns of No. 28 S. S. C. wire are used. This is also wound with a half-inch space in the center, 20 turns on either side. Two flexible leads are brought out from both ends of the tickler winding.

ASSEMBLY

The general plan of assembling can be easily worked out from the illustrations. No binding posts are shown, but it is suggested that a strip of insulating material be placed across the back. Upon this the binding posts can be placed and all connections made to the rear. An automatic filament lighting jack should be used. Incidentally, the jack may support the tube socket and grid leak platform.

WIRING AND CONNECTIONS

Use No. 13 tinned copper wire

HERBERT H. FROST, Inc.

154 WEST LAKE STREET, CHICAGO, ILLINOIS.

FROST-FONES

Super-inspected Quality Fones and Radio Parts

Frost-Fones are built as precisely as a delicate watch. Specially inspected to insure sensitivity and permanent strength. Frost-Fones excel for hearing local broadcasting stations or distance work.

Quantity production and efficient factory methods explain the low price of Frost Quality Fones.

America's leading jobbers and dealers sell Frost-Radio Equipment. Save money and insure satisfaction by insisting on Frost-Radio.

HERBERT H. FROST, Inc.
154 West Lake Street Chicago



No. 400—Frost-Radio Receiving Transformers, \$8.50

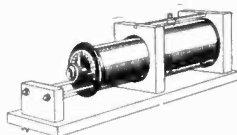

No. 137—Frost-Radio Cord Tip Plug, \$1.25.



No. 138—Frost-Radio Multi-Phone Plug \$2.50.

The Thrill of Love!!!
Do WOMEN LOVE Better?

The Thrill of the Human Touch!

Should a woman advertise for a mate?

Why Should a Girl Be Married Before 18 and the Man Before 21?

Marriage, Divorce, Love, Eugenics, Birth Control, Sex Hygiene, etc., etc.

How to Marry Successful and Attain Happiness

These are only some of the subjects exclusively dealt with in every issue of the "FOLD" MAGAZINE, America's big and high class LOVER'S PUBLICATION. Devoted only to such problems.

Send 10c for Sample Copy and complete information about our Friendship Club

SUBSCRIPTION PRICE NOW ONLY 75c PER YEAR, 3 YEARS FOR \$2.00.

This special offer to increase the circulation of the "FOLD" is good only for a short period. Every subscription includes FREE membership to our FRIENDSHIP CLUB, with thousands of members (both sexes) in every state and city.

Send 75c with your name and address to the

"FOLD" MAGAZINE
1151 Broadway, N. Y. City

MISSOURI, Jr. Receiving Set

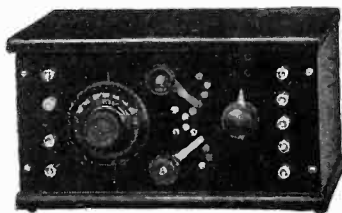

Little Giant of the Radio World

It Gets the Distance

Has entirely new circuit or "hook up." Phenomenal distance—St. Louis, for example, gets Los Angeles, Key West, Boston, etc. Just what you've been waiting for.

A 1,000-mile reception guaranteed or purchase price refunded.

\$45

(delivered)

Including head phones, B battery and detector tube. Catalog showing complete line of various styles and sizes sent on request.

Missouri Radio Corp.

2609 Washington Ave., St. Louis.

Some valuable territory open for dealers



WE ARE DISTRIBUTERS OF "GARRETT & CO'S. inc. VIRGINIA DARE VERMOUTH. TO INTRODUCE THIS WONDERFUL NON-ALCOHOLIC DRINK SPECIAL PRICE \$11.00 PER 12 QUARTS. WRITE FOR OUR LATEST CATALOGUE MAILED FREE CONTAINING SPECIAL OFFERS. ASK ABOUT OUR-VINOBAR-IT IS GREAT" MONTREAL BOTTLERS CORP. 129 E. 59th ST. NEW YORK CITY

Radio as a Profession

Today radio is progressing at a rate unheard of in any other industry—its rapid growth and world-wide expansion is unprecedented. Not only are the world's foremost manufacturing and radio commercial companies making greater strides and extending their activities, but the governments themselves are fast taking advantage of this new science—erecting broadcasting stations—air service stations in expediting and aiding in government-public utilities.

Each new step and every additional radio station requires trained radio men. Ships of all classes require trained radio men—men who possess Government License Certificates, but who, before they can secure such licenses, must be properly trained and must pass a satisfactory examination as given by the U. S. Department of Commerce.

Why not qualify YOURSELF to obtain a license and privilege YOURSELF to a position on any ship or shore radio station in the United States? Qualify yourself through the Radio Institute of America—America's oldest established and foremost school devoted to the practical science of Wireless Telegraphy and Telephony—an institution that has graduated over 6,500 students, of whom more than 95 per cent have obtained successful positions in the radio field. **OVER 90 PER CENT OF THE WIRELESS OPERATORS IN THE EMPLOY OF THE RADIO CORPORATION OF AMERICA, THE WORLD'S FOREMOST RADIO COMPANY, ARE GRADUATES OF THE RADIO INSTITUTE OF AMERICA.**

For the benefit of those who cannot attend the Institute personally we have organized a Home Study Correspondence School Division—a systematic course of training supervised and conducted by the Institute's staff of experienced and expert instructors.

The Home Study Course includes everything from the basic principles of electricity and magnetism through to actual commercial radio equipment, including Arc, C. W., I.C.W., Telephone, direction finding apparatus, everything modern and known in present day Wireless Communication. It also includes the same text books used in the Institute's class rooms, as well as a buzzer set of greatly improved design with a variable automatic transmitter (special construction) for code practice.

A THREE WEEKS' POST-GRADUATE COURSE IN THE NEW YORK RESIDENCE SCHOOL IS GIVEN WITHOUT EXTRA CHARGE TO STUDENTS OF THE HOME-STUDY DIVISION.

The graduates of the Radio Institute of America enjoy a great and exclusive advantage in the close connection existing between the Institute and the Radio Corporation of America, the world's largest radio manufacturing and commercial radio company.

Send for our free booklet "Radio—the new field of unlimited opportunity"—it will tell you of the great things taking place in the radio world and show you the great opportunity awaiting properly trained radio men—**SEND FOR IT TODAY.**

Radio Institute of America

(Formerly Marconi Institute)

330 Broadway

New York City

Branch Resident School
New Call Building, New Montgomery St., San Francisco, Calif.

Direct Reading Wavemeter
Price **\$68.00**

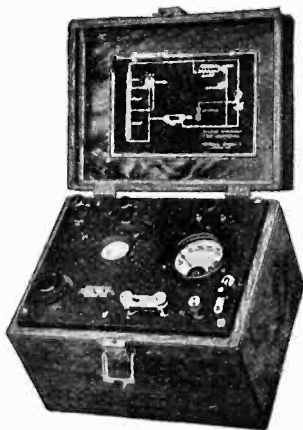

Type 174-E

Q - R - H

You may be able to guess, but we recommend that you know by using a reliable wavemeter. The Type 174-B Wavemeter is direct reading, has a range of from 150-3,000 meters, and may be used with receiving or transmitting sets employing either damped or undamped waves.

Send for **FREE BULLETIN 707-T**
and learn about wavemeters.

GENERAL RADIO COMPANY

Massachusetts Avenue and Windsor Street

CAMBRIDGE 39

MASSACHUSETTS

Standardize on GENERAL RADIO COMPANY equipment throughout—

DO NOT CONFUSE the products of the GENERAL RADIO CO. with those of other concerns using the words "General Radio." The GENERAL RADIO CO. has been manufacturing radio and scientific instruments for many years. It has no affiliation with any other company.

for wiring and solder all connections. The circuit diagram is shown in Fig. 2. The hook-up is both unusual and unique. The variable condenser is connected in parallel to the secondary and one of the .00025 condensers is used in the grid circuit, the other across the phones.

OPERATION

Refer to upper Fig. 1. The phone plug is placed into the jack just below the rheostat knob. This automatically lights the tube. The second knob from the left is the variable condenser with which most tuning is done. The next knob is the tickler.

For 200-meter reception, the first of the three secondary taps should be used and the first to sixth tap on the lower primary contacts. For 360 meters the contact arms should be in just about the same position as they are drawn in upper Fig. 1.

Using a one-wire aerial 42 feet long and 40 feet high on this set and one stage of audio-frequency amplification, the Institute has heard consistently amateur and broadcasting stations within a 1,000-mile radius. The set tunes very sharply and at the same time it is easy to manipulate. Further information on the set may be secured from RADIO TOPICS INSTITUTE, 1114 North boulevard, Oak Park, Ill.

ELEMENTARY ELECTRICAL PRINCIPLES

(Continued from page 36)

articles are requested to send in their answers on the above problems and questions to the writer for grading, and those amateurs who study carefully all this work and submit correct answers will receive honorable mention each month in RADIO TOPICS. RADIO TOPICS will also present each amateur with a certificate of proficiency after each six lessons are completed. It is necessary that the students must submit their lesson sheets regularly and within one week after the issue of RADIO TOPICS is in their hands after leaving the press.

GET BUSY AND LET'S SEE WHO RECEIVES HONORABLE MENTION IN EACH MONTH'S ISSUE. ADDRESS YOUR ANSWERS TO ELECTRICAL EDITOR, RADIO TOPICS, OAK PARK, ILLINOIS.



BUILD YOUR OWN RADIO SET, 20 CENTS

Special offer: Complete 50c text book for only 20c postpaid. Wonderful information makes you understand radio. Tells how radio messages are received. Tells how to make eight different classes of crystal and vacuum tube receiving sets with ranges of from 25 to 2000 miles. Detail drawings and complete bills of material given for each set. We enclose price list of parts required to make these sets. Buy direct from factory and save many dollars. Nothing else like this book on the market. Money back if not satisfied.

RADIO PARTS MANUFACTURING COMPANY

Desk 18

Park Place, Detroit, Mich.

HOME CHARGING YOUR RADIO BATTERY

WHILE there has been some very successful receiving sets developed, operating from dry cells, the great majority of those in use, and likely to be sold in the future, require a storage battery for heating the filament in the detector and amplifying bulbs.

The maintenance and recharging of this storage battery has proved the bugaboo which has prevented many a radio fan, not familiar with the facts, from buying or making a real receiving set with several stages of radio or audio amplification, or both. There is no real reason, however, for this feeling, as any storage battery of reputable make will last for several years in radio service without any attention or trouble, excepting the addition of distilled water from time to time and recharging when exhausted.

It is admittedly, however, quite inconvenient and expensive to lug a storage battery to a service station every time it requires recharging, which, in the case of a receiving set employing several bulbs, may be once every week. Fortunately, however, there are many makes of chargers on the market retailing at a popular price, which enables the radio fan to charge his battery at practically no expense, and without removing it from the receiving room.

While many of these devices require some electrical knowledge for their successful operation, the majority of them are extremely simple in the construction, and can be successfully operated by anyone. The most efficient of these chargers will fully recharge any "A" battery overnight with a current consumption of less than one K. W. Hour, which, based on the average cost of electrical current throughout the United States, amounts to but 5 cents.

In the purchase of such a rectifier it is important that the buyer consider the following points:

ONE—Self-Polarizing Feature: With a rectifier of this type battery may be connected either way and will always charge. Otherwise, it requires considerable knowledge and skill to determine proper battery and rectifier po-

An Improved, Noiseless Rheostat for Only \$1.60

Sectional, side view of the Gollos Mercury Rheostat.

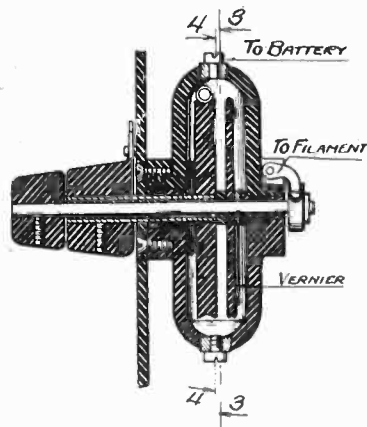

Below are shown the mechanical and electrical actions.

The Gollos Mercury Rheostat

Compactly contained in an air-tight, dust-proof case, the main resistance wire and the vernier resistor revolve through a small well of mercury.

Operation is noiseless, steady and foolproof. It will last a lifetime.

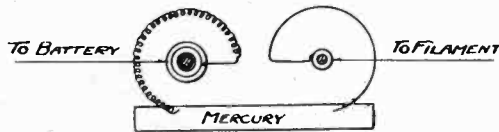
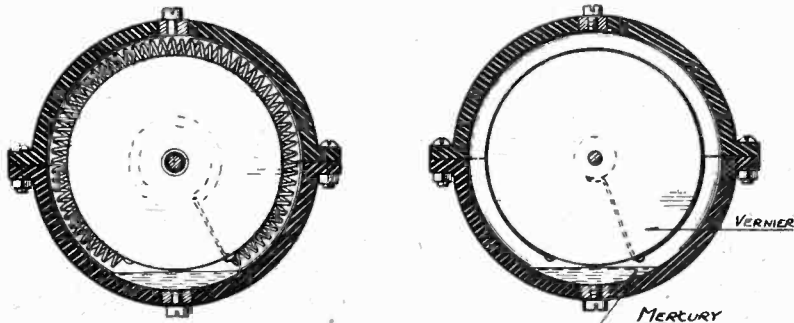

The best rheostat on the market at the lowest price.
Only \$1.60 complete.

DEALERS' AND JOBBERS' INQUIRIES SOLICITED

Gollos Electrical Devices Co.

118 N. La Salle St., Suite 704

Chicago

PLAY SAFE!

Insist on Getting UNITED PRODUCTS

Follow the example of the Radio-wise experts, who buy each part with an exact knowledge of its true value.

United Audio Frequency Transformers amplify weak sounds; bring in distant stations, with clear, pleasing distinctness.

A beautiful piece of workmanship with sturdy steel shell, furnished in black enamel with buffed nickel strip, \$4.50.



Patent Applied For

UNITED VARIABLE CONDENSERS

Correct in design, high grade in workmanship. Plates are held positively, so that short-circuiting is practically impossible.

LIST PRICES

43 plate	\$4.50	United Variable Con-
23 plate	4.00	densers, with Vernier at-
11 plate	3.50	tachment, dial and knob:
5 plate	2.75	46 plate
3 plate	2.25	26 plate
Without dial or knob.		5.50

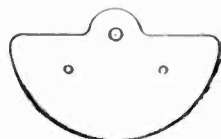
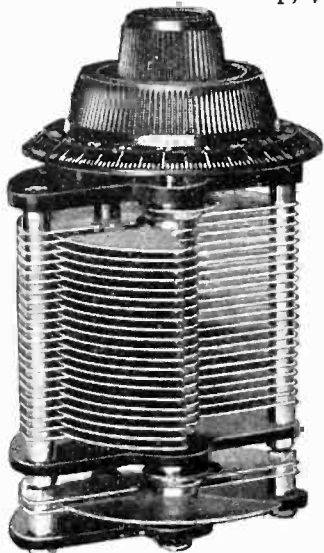

Mounting made easy by our template for locating panel holes; packed free with each condenser.

United Transformers and Condensers have been adopted as standard equipment by leading makers of radio receiving sets. Their judgment is a safe guide for you.

Tell your dealer you want "United" or nothing. Circular Free.

UNITED MFG. AND DISTRIBUTING CO.
536 Lake Shore Drive **CHICAGO**

larity, and should battery be connected the wrong way, it is likely to be ruined, or, at least, seriously harmed through reverse charging.

TWO—At Least a Five Ampere Charging Rate: With a charging rate of five amperes or more any battery of eighty ampere hour or less capacity may be fully charged overnight. Where a lower charging rate is employed a corresponding greater time is required. For instance, with a rectifier delivering but two amperes about fifty hours continuous operation is required to fully charge a battery, during which time, of course, it is impossible to use the receiving set.

THREE—Underwriters' Approval: The National Board of Fire Underwriters are becoming more strict in the enforcement of rules covering the use of only approved electrical apparatus. Any rectifier having the Underwriters' approval has been carefully tested by them and possesses practically no fire hazard. Considerable difficulty may be experienced in effecting an adjustment with the Insurance Company in case of fire, if the rectifier you are using has not been approved by them.

After your rectifier has been purchased, it is advisable to secure a hydrometer from your dealer for telling when your battery needs recharging. This instrument can be purchased for 50 cents to \$1, and will pay for itself many times over through elimination of unnecessary charging.

A new storage battery should always be given an overnight charge before used, since it has most likely been several months since recharged at the factory.

Maximum receiving range and strong, clear signals are obtained best when your battery is fully charged. For this reason it is always well to keep your battery in as near full charged condition as possible.

By taking a hydrometer reading after an evening's use of your receiving set, if the specific gravity of battery is below 1,200, it is best to charge battery overnight. It will then possess maximum power, be ready for a long period of use, and will bring in the signals stronger and increase the receiving range of your set.

Awkward Binding Posts

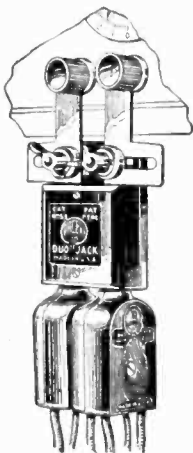

are immediately changed to convenient jack equipment by the Pacent Duojack. It also provides for connection of two sets of phones or a head set and loud speaker.

Other PACENT Plug and Jack devices, which will increase the pleasure of operating your equipment, are the PACENT Universal Plug, PACENT Multijack, PACENT Twinadapter and PACENT Jacks.

DON'T IMPROVISE—"PACENTIZE!"

Write for Descriptive Bulletins T. J.-101.

PACENT ELECTRIC COMPANY

INCORPORATED

Manufacturers and Distributors of Radio and Electrical Essentials
EXECUTIVE OFFICES: 22 PARK PLACE, NEW YORK, N. Y.

Branch Offices

Philadelphia, Bourse Buldg.
Chicago, 33 So. Clinton St.

Washington, D. C., Munsey Building

San Francisco, Sheldon Building

Canadian and British Licensees:

Colonial Radio, Ltd., Hamilton, Canada



Cat. No. 53

PRICE

\$1.50

Members, Radio Section, Associated Mfrs. of Electrical Supplies

WANTED

Cash for Old Gold, Platinum, Silver, Diamonds, Liberty Bonds, War, Thrift, Unused Postage Stamps, False Teeth, Magneto Points, Jobs, Any Valuables. Mail in today. Cash sent, return mail. Goods returned in ten days if you're not satisfied. Ohio Smelting Co., 336 Hippodrome Bldg., Cleveland, Ohio.

FOR SALE

Fifty complete hook-ups, from crystal set to latest Armstrong super-regenerative receiver, clearly illustrated with descriptions; 20 cts. Westboard Engineers, 309 Canal St., New York.

SALESMEN that have been or are calling on electric or radio trade, see Mr. Rice, 6311 N. Clark St., Chicago.

HOW TO AVOID INTERFERENCE

By C. W. HORN

In order to assist radio broadcasting, the Department of Commerce has specified two wavelengths on which broadcasting may be conducted. These wavelengths are 360 meters, the one in general use up to this time, and 400 meters, just recently allotted. While these wavelengths are 40 meters apart, undoubtedly there will be considerable confusion on the part of those owning radio receivers who are located very near a broadcasting station.

For the purpose of assisting those who are located so that a 360 meter and a 400 meter station are picked up by their receivers simultaneously, a number of methods will be described, which, if applied, should greatly assist those desiring to get either one of the two waves without interference. There is one case, however, which will be very difficult to assist; that is, where the receiver is exceptionally near to a broadcasting station—say within a few thousand yards.

The assignment of two wavelengths so close together will have the effect of stimulating construction of radio apparatus which will be capable of tuning more sharply, and it is the case of "necessity being the mother of invention." Therefore while there may be some inconvenience at the present time, this should be overlooked in order to help the radio game by creating a condition which will stimulate the construction of better apparatus, and which will permit the assignment of more wavelengths, ultimately creating a better situation in the ether.

One of the greatest faults that has been found in connection with the installation of radio receiving apparatus is that it is believed that the more wire and the larger the antenna, the more will be received. An exceptionally large antenna makes it more difficult to tune sharply, and for this reason it is advocated that a very short, single wire antenna, approximately 75 feet long, measuring from the apparatus to the far end, be used. This single wire antenna should be stretched away from all metallic objects and run straight and clear of all obstructions.

Another fault in the installation

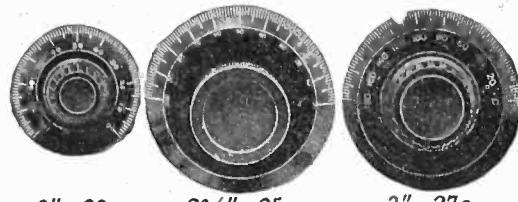

2" 20c 2³/₄" 25c 3" 27c

\$1.75
"SESCO"
Vario Coupler
600 Meters



\$2.50
"SESCO"
Variometer

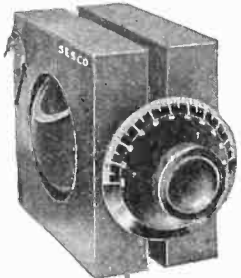

\$1.00 with order, balance C. O. D.
Standard Mod. Phones, 2,500 Ohms, \$5.75.

Standard Electric Sales Co.

843 Broad St., Newark, N. J.

Don't Wear a Truss

BE COMFORTABLE—Wear the Brooks Appliance, the modern scientific invention which gives rupture sufferers immediate relief. It has no obnoxious springs or pads. Automatic Air Cushions bind and draw together the broken parts. No salves or plasters. Durable. Cheap. Sent on trial to prove its worth. Never on sale in stores as every Appliance is made to order, the proper size and shape of Air Cushion depending on the nature of each case. Beware of imitations. Look for trade-mark bearing portrait and signature of C. E. Brooks which appears on every Appliance. None other genuine. Full information and booklet sent free in plain, sealed envelope.

BROOKS APPLIANCE CO.
221-B State St., Marshall, Mich.



C. E. Brooks



NA-ALD

De Luxe
V. T. Socket

Contact strips of laminated Phosphor bronze press firmly against contact pins, regardless of variation in length. No open current trouble possible. Socket unbreakable. Special protected slot, with exterior reinforcement. Unaffected by heat of bulbs or soldering iron. All excess metal eliminated, aiding reception. May be used for 5 Watt power tube. Highest quality throughout. Price 75c.

Special proposition to dealers and jobbers

Alden-Napier Co.
52 Willow St., Dept. E, Springfield, Mass.

SPECIAL INVENTORY SHEETS

We have compiled several sheets of miscellaneous apparatus and parts, etc., so priced that it can be removed quickly before inventory is taken, to make room for new lots of apparatus parts, etc., for the first of the year.

Postcard mailed to us today will immediately bring to your door these Special Inventory Sheets, free of charge.



QUALITY RADIO APPARATUS

Dept. R Summit, Illinois.

May we give you any of these ?

MANHATTAN PHONES
FROST PHONES

WORKRITE PHONES
1 VARIOMETER
1 VARIOCOUPLER

Any one of these are worth \$6 to \$9. Send us 3 subscriptions to Radio Topics or your own for 3 years—total \$6—check the item desired, and it's yours by return mail.

RADIO TOPICS, Subscription Manager
1112 North Boulevard Oak Park, Ill.

3000 Ohm Sets \$3.98

PLUS 20C POSTAGE AND PACKING.
Satisfaction Guaranteed or Money Back.



We mail phones the day your order arrives. Every pair tested, matched and guaranteed as sensitive as \$8 to \$10 Sets. Circular Free.

TOWER MFG. COMPANY
116 Station St., Brookline, Mass.

**Kellogg V-T Socket**

the durable socket
Kellogg molded lamp sockets fit all standard four prong based vacuum tubes. Extra heavy solid base 7-16 inches thick.

75c ea. Four German silver springs with rounded ends firmly held in position in deep grooves, cannot touch mounting surface. Double end nickel plated binding posts. Connections can be made under the socket as well as above. A practically indestructible construction. 75c each, postpaid.

COMPLETE RADIO EQUIPMENT
The item above is merely a sample of the excellent line of radio equipment that is handled by the Apex Radio Company, Inc. All orders for sockets or other standard equipment will be filled the day received. Send two cent stamps for our new price bulletin.

APEX RADIO CO., INC.
1105 W. 69th St.
Chicago, Ill.

RADIO PANELS

Cut exactly to size and shipped the same day your order is received— $\frac{1}{4}$ in. thick, \$.01 $\frac{1}{2}$ per sq. in.; 5-16 in., .02c. Made of the highest grade of black fiber. This material possesses high dielectric strength, is inexpensive, unbreakable, takes a nice finish, and is easy to work. We pay Postage—Try Us.

Radio Instrument & Panel Co.
26 N. Desplaines St., Chicago Ill.

RADIO

We carry a full line of Radio Sets and Supplies of the best makes. Hear our sets before buying.

Chicago Electrical Supply Co.
360 W. Madison St. CHICAGO, ILL.

ESTRU

Lattice Variometers
List Price \$5

Dalton, Whittier, True
2905 West Madison Street
CHICAGO

JOY-KELSEY CORPORATION
Manufacturers
RADIO EQUIPMENT
4021 West Kinzie St. Chicago Ill.

of receiving apparatus can be eliminated by not running the antenna or lead-in over metal roofs, along water spouts or drains, or parallel to telephone and power wires.

Frank Conrad, assistant chief engineer of the Westinghouse Electric & Manufacturing Company, has made measurements and drawn resonance curves which show that a short low antenna tunes more sharply than a large and long antenna. This holds true both for coupled and single circuit tuners.

Another method to pursue in overcoming interference, especially where vacuum tube receivers are used and where the receiver is located close to a broadcasting station, is to make use of the well-known directional properties of the loop antenna. A very simple loop can be constructed by winding half dozen turns of wire spaced about one inch apart, on a framework, which can be rotated. It will then be easy to tune out a station which has a difference of 40 meters in wave length, especially so as a loop antenna forms a closed circuit which can be more sharply tuned than an open antenna. The two ends of the loop should be connected across the antenna, the ground terminals of the receiver, and no other ground or antenna used.

Those who are located a greater distance from a broadcasting station can, without any difficulty, tune in either one of the wavelengths mentioned. They should, however, bear in mind that a single wire antenna, not too long, and kept free from obstructions, and not running near grounded metallic objects, will tune sharper. Where the amateur has a transmitting apparatus it is of course desirable to have a fairly large antenna, with more than one wire, and if such is the case he should use a separate wire for receiving.

The ideal condition will be when stations can operate independently on either of two wavelengths without interfering with each other, and because the receiving apparatus is an important factor these suggestions are given in order that owners of receiving apparatus may have the necessary information to increase the efficiency of their apparatus.

Loud Speaker \$1

Adapter

Hear all broad-casting through phonograph. Make your own horn. Attach B-R Phonadapter to YOUR phonograph. All can hear. Entire family, neighbors, guests can hear operas, lectures, latest news, with this adapter. Stretches over receiver of Baldwin or Brandes type head-set and attaches to tone-arm of ANY phonograph. Made of soft, pure gum rubber. Quickly attached and removed. Thousands in use. Absolutely no voice distortion. For single receiver.....**.75**
For pair of receivers (more than twice the volume) **\$1**

Amplitone Loud Speaker
An inexpensive, loud speaking horn especially adapted for home use. Ample volume. Quality tones. Throat of horn consists of successive sound expansion chambers. Each chamber amplifies previous one. Furnished either with single or double B-R Phonadapter. Price **\$8** only.....

Bell Horn
A Bell Horn with ball swivel. Turns up, down, to side—any angle desired. Automatic adjustment. Very simple. No screws, thumb nuts, etc. Black finish. Complete, with phone, ready to attach to two stage amplifier.....**\$15**

The Beckley-Ralston Co.
1833 So. Michigan Ave.
Chicago, Ill.

Go to your dealer. If he cannot supply you send money order, check or currency at our risk. Prompt delivery—postpaid. Also send us name of favorite dealer.



35c each, 3 for \$1.00

Na-ald

GENUINE CONDENSITE DIAL

The dial that runs true

Numerals engraved on bevel and knob so shaped that fingers do not hide them. Thin edge with clear graduation to make accurate reading easy. Concealed set screw in metal insert. Will not warp or chip. Finish and enamel permanent.

Low price with this quality possible only through quantity production.

Special dealer and jobber proposition.
An opportunity.

Alden-Napier Co.

52 Willow St., Springfield, Mass.
Dept. E

PATENTS**To the Man with an Idea**

I offer a comprehensive, experienced, efficient service for his prompt, legal protection and the development of his proposition.

Send sketch of model and description, for advice as to cost, search through prior United States patents, etc. Preliminary advice gladly furnished without charge.

My experience and familiarity with various arts frequently enable me to accurately advise clients as to probable patentability before they go to any expense.

Booklet of valuable information and form for properly disclosing your idea free on request. Write today.

Richard B. Owen, Patent Lawyer
81 Owen Bldg., Washington, D. C.
2278-M Woolworth Bldg., N.Y. City

JUST WHAT YOU WANT! WORKRITE Concertolas

\$12

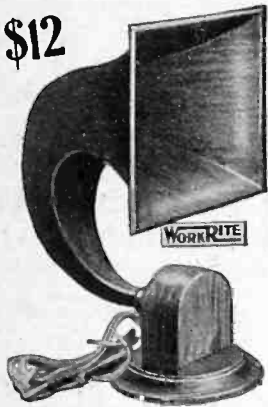

Concertola Jr.

A graceful, beautifully constructed instrument, harmonizing with your house furnishings.

HERE they are—the loud speakers produced by the WorkRite engineers—Concertola, Sr. and Jr. Perfected until they are worthy of the name WorkRite. Hundreds of thousands of radio fans who have used WorkRite Radio Products know that “WorkRite” means perfection.

WorkRite Concertolas accurately reproduce music or voice from the broadcasting station without the slightest distortion.

The sound chamber in both of these instruments is made from our specially developed material. Why listen to music through a “tin-panny” metal horn that loses all the beautiful tones of the artists, when you can buy WorkRite Concertola that will give you perfect reproduction of voice and music?

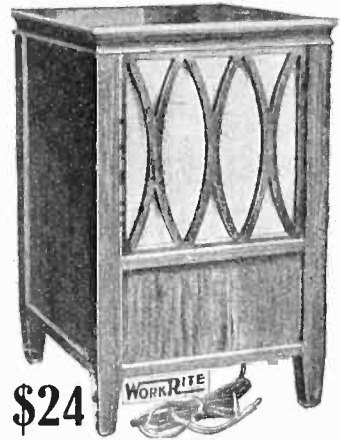

\$24

Concertola Sr.

Made from the finest grade mahogany with handsome rubbed finish.

EXCEPT FOR THE PHONE

There is Not the Slightest Metal Used in Either the WorkRite Concertola Sr. or Jr.

IMPORTANT

The best sound amplifier will not get results with an ordinary head phone. Our engineering department has developed the WorkRite Concert Phone for just one purpose—to be built in the WorkRite Concertola, Sr. and Jr., making a combination that is unequalled. This special phone is not sold separately from the Concertola. Phones and cord are built in each instrument.

Let Whole Family and Friends Enjoy the Radio Concerts!

Double the pleasure of your radio by sharing it with others. The air is full of entertainment for all. Just plug in a WorkRite Concertola instead of your head set (two steps of amplification are necessary) and your home will be full of music.

WorkRite Concertola Jr. \$12

WorkRite Concertola Sr. \$24

BEFORE BUILDING A SET WRITE for OUR FREE CATALOG!

New WorkRite Super Vernier Rheostat

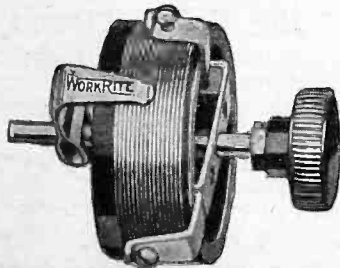

Here is a real Vernier Rheostat—something entirely new and very much needed. Can be instantly changed from 6½ ohms resistance to zero by simply pushing in the knob, or you can have unlimited adjustments by turning the knob. Increase the efficiency of the set. Screws for mounting on panel furnished. The WorkRite Rheostat is really remarkable in its performance and is easily worth twice the price asked. No set should be without it. Price\$1.50

WorkRite Super Variometer

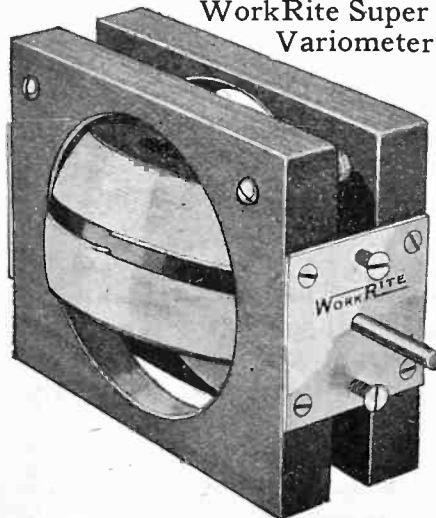

THE WORKRITE VARIOMETER is made from finest quality mahogany. All windings are perfectly made, and connections cleverly concealed. Green silk winding on rotar, white silk winding on stator. Substantially built throughout. WORKRITE VARIOMETER packed in attractive box, \$5.25 With WorkRite E-Z-Tune Dial.... 6.00

JOBBERs and DEALERs
Write or Wire for discounts

WorkRite 180° Super Variocoupler

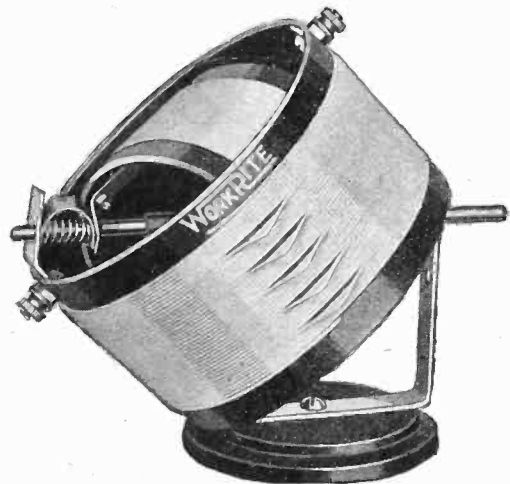

THE WORKRITE VARIOCOUPLER represents perfection in getting all dimensions and number of wire turns just right. Tunes twice as sharp as the ordinary 90-degree coupler. Green silk wire wound on polished formica, with 12 taps. WORKRITE VARIOCOUPLER packed in attractive box\$5.00

With WorkRite E-Z-Tune Dial.... 5.75

THE WORKRITE MFG. CO. 5543 Euclid Avenue CLEVELAND, OHIO

R-N. 10227

(Branch Office: 2204 S. Michigan Ave., Chicago)

RADIO COURSE FREE

the minute and includes all the latest wireless developments. Mail the coupon for full particulars. L. L. Cooke, Chief Engineer.

For a limited time I will give my new Radio Course, just completed, absolutely FREE with my Course in Practical Electricity. This new course is right up to

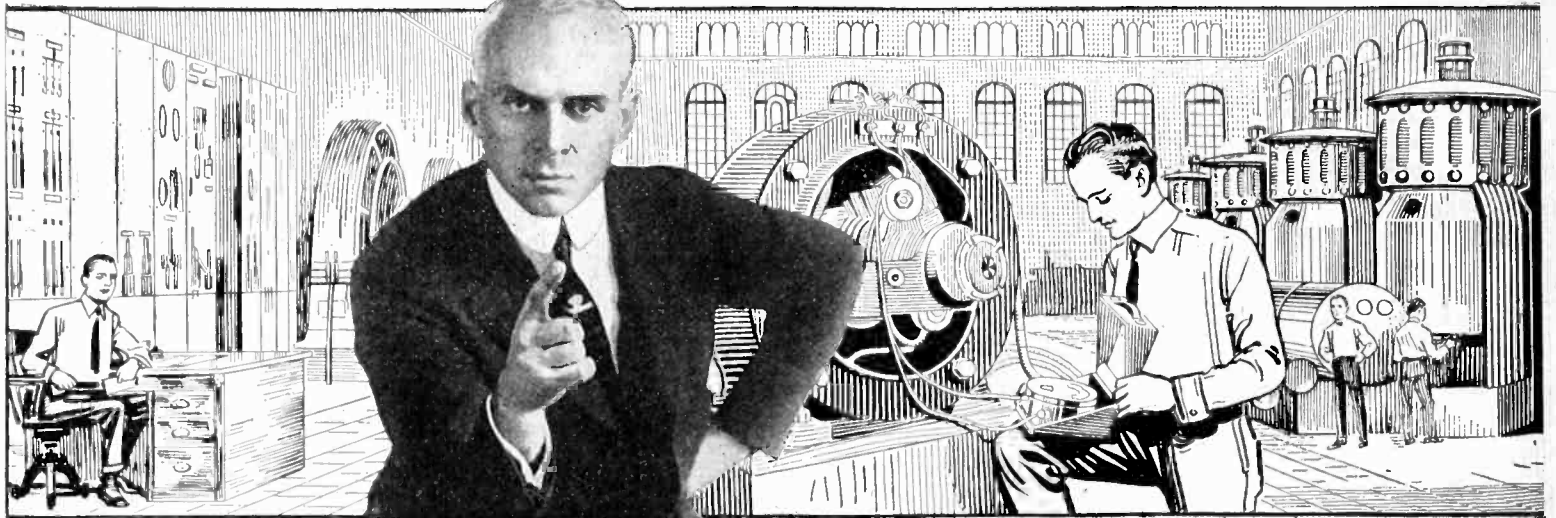

ELECTRICITY NEEDS YOU

I Will Train You at Home

Stop right here. This is your opportunity! Electricity is calling you, and the Electrical Business is in for a tremendous increase. But it needs more trained men—at big pay. By my Home Study Course in Practical Electricity I can train you for these positions.

EARN \$70 TO \$200 A WEEK

You've always had a liking for Electricity and a hankering to do electrical jobs. Now is the time to develop that talent; there's big money in it. Even if you don't know anything at all about Electricity you can quickly grasp it by my-up-to-date, practical method of teaching. You will find it intensely interesting and highly profitable. I've trained and started hundreds of men in the Electrical Business, men who have made big successes. YOU CAN ALSO

BE A BIG PAID ELECTRICAL EXPERT

What are you doing to prepare yourself for a real success? At the rate you are going where will you be in ten years from now? Have you the specialized training that will put you on the road to success? Have you ambition enough to prepare for success, and get it?

You have the ambition and I will give you the training, so get busy. I am offering you success and all that goes with it. Will you take it? I'll make you an ELECTRICAL EXPERT. I will train you as you should be trained. I will give you the benefit of my advice and 20 years of engineering experience and help you in every way to the biggest possible success.

CHIEF ENGINEER COOKE
Chicago Engineering Works
Dept. 1375, 2150 Lawrence Ave.
CHICAGO, ILL.

Dear Sir: You may send me entirely free and fully prepaid, a copy of your book, "How to Become an Electrical Expert," and particulars about your Home Study Course in Electricity and the Free Radio Course.

Name

Address

City State.....

Valuable Book Free

My book, "How to Become an Electrical Expert," has started many a man on the way to fortune. I will send a copy, free and prepaid, to every person answering this advertisement.

Act Now!

Good intentions never get you anywhere. It is action, alone, that counts. NOW IS THE TIME TO ACT.

L. L. COOKE, Chief Engineer
CHICAGO ENGINEERING WORKS
2150 LAWRENCE AVENUE
Dept. 1375, Chicago, U. S. A.

FREE!

Big Electrical Outfit

A fine outfit of Electrical Tools, Instruments, Materials, etc., absolutely FREE to every student. I will also send you FREE and fully prepaid—Proof Lessons to show you how easily you can learn Electricity and enter this splendid profession by my new, revised and original system of Training by Mail.

I Guarantee You Satisfaction

So sure am I that you can learn electricity—so sure am I after studying with me, you, too, can get in the "big money" class in electrical work, that I will guarantee under Bond to return every single penny paid me in tuition if, when you have finished my Course, you are not satisfied it was the best investment you ever made.

Earn Money While Learning

I give you something you can use now. Early in my Home Study Course I show you how to begin making money in Electricity, and help you get started. No need to wait until the whole course is completed. Hundreds of students have made several times the cost of their course in spare time work while learning.

BUILD YOUR OWN RADIO

and Get a
Sixty-Dollar
Outfit for **\$20.00**

We furnish all parts complete; give you easily-followed instructions for assembling. No shopping 'round for parts or wasting time and money on parts that don't fit.

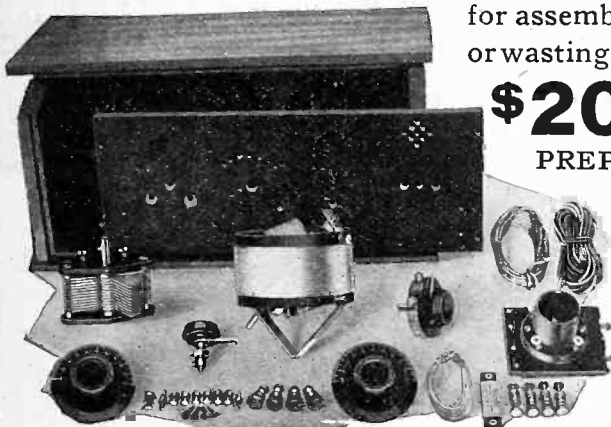

VIEW OF UNASSEMBLED SET

\$20.00
 PREPAID

**Screw-
 driver and
 Pliers
 Are Only
 Tools
 Needed**

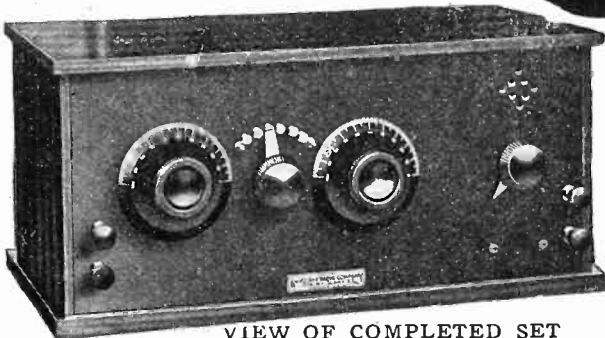

VIEW OF COMPLETED SET

OUR LOT NO. 1—\$20 OUTFIT Includes the following

1 Cabinet (panel size) 6x14 in.....	\$3.30	4 Hard Rubber Binding Posts.....	\$.28
1 3-16 in. Formica Panel drilled, marked and lettered.....	4.68	1 Switch Lever50
1 23 Plate Condenser.....	2.65	6 Switch Points.....	.18
1 180 Degree Coupler.....	5.00	2 Stops06
2 Dials	1.00	15 Ft. No. 14 Copper Wire.....	.15
1 Rheostat	1.10	5 Ft. No. 22 D. C. C. Wire.....	.05
1 Socket55	12 Ft. Varnished Tubing.....	1.20
1 Base35	Screws and nuts.....	.50
1 Grid Leak and Condenser.....	.75	COST IF BOUGHT	
4 Nickel Plated Binding Posts20	SEPARATELY	\$22.50

**ALL FOR \$20 PRE-
 PAID—MAKING A SET
 THAT WOULD COST
 YOU AT LEAST \$60 IF
 BOUGHT ASSEMBLED**

OUR LOT NO. 2 ACCESSORIES

If you have not the following accessories, which are necessary to make this a complete phone receiving unit, ready to tune in, you can purchase them from your local dealer or from us at the following prices:

1 Eveready "A" Battery (90 Amp. hours).....	\$18.00	200 feet Antenna Wire.....	\$ 1.80
1 Eveready "B" Battery.....	1.70	50 feet Ground Wire.....	.60
1 Pair Frost Phones.....	5.00	1 Lightning Arrester	1.50
1 Vacuum Tube.....	5.00	1 Ground Clamp20
6 Insulators	1.20	COST IF BOUGHT	
		SEPARATELY	\$35.00

**OUR PRICE IF
 BOUGHT IN ONE
 LOT, \$30 PREPAID**

Combine lot No. 1 (\$20.00 set) with lot No. 2 and at a cost of only \$50.00 you have the "makings" of a long-distance radio outfit—the equal of any \$100.00 complete set on the market

"LEFAX" RADIO HANDBOOK FREE

What's more, for a limited time we will give you FREE a copy of the \$3.50 Lefax Radio Handbook with your first order for Waveland products amounting to \$20 or more. Your name stamped in gold on the front cover if desired.

"WAVELAND PAYS THE POSTAGE"

ORDER NOW, sending us cash, money order, draft or check, and we will immediately ship you the parts prepaid with our guarantee that if you are not completely satisfied you may return them at our expense and we will instantly return your money.

DON'T WAVER—WRITE WAVELAND

WAVELAND RADIO COMPANY

INCORPORATED

1350 North Clark Street

Chicago, Illinois



THE Westinghouse station KDKA at East Pittsburgh is reported to be conducting tests, broadcasting on the low wavelength of 100 meters. As practically none of the sets now in use can be tuned this low, the object may be to open a new field for the manufacture of receiving sets which will tune to 100 meters.

The White Bill for new radio legislation, presented some months ago, still remains in the hands of the committee on Merchant Marine and Fisheries where it is receiving no attention. Unless it is forced before Congress during the present short session it cannot be brought up again before another, which means that the new legislation will not have any effect until 1925. It is the duty of every radioman to write his congressman demanding that this White Bill be given an immediate hearing.

Mr. Spendix — "Any installments due today?"

Mrs. Spendix—"No, dear, I think not."

Mr. Spendix—"Any payments due on the house, the radio, the furniture, the rugs or the books?"

Mrs. Spendix—"No."

Mr. Spendix—"Then I have ten dollars we don't need. What do you say we buy a new car?"—New York Sun.

The girl reporter accepted the editor's invitation to dinner and when asked how she enjoyed it, said:

"Oh, fine, but I'll never go to dinner with an editor again."

"Wy not?"

"Well, the dinner was fine, but he blue-penciled about three-quarters of my order."—Brooklyn Eagle.

Starting in the February issue one of the best known writers in the radio field, Milton B. Sleeper, will supply our readers with his splendid construction articles.

Everyone remembering M. B. West and his interesting articles will be glad to learn that he is now writing some exceptional material for exclusive publication in an early issue of RADIO TOPICS.

For those technically inclined, the U. S. Bureau of Standards has recently published circular 75, "The Secondary Standardization of Inductors at Radio Frequencies," LC 77, "The Comparison of Condensers at Radio Frequencies," (this is published elsewhere in this issue), and LC 78, "Design of a Portable Short-Wave Radio Wavemeter." Copies may be obtained from the Superintendent of Documents, Washington, D. C., for five cents.

A prominent man was asked a short time ago for information in regard to a youth whom a firm was considering taking into their office. He wrote:

"I believe Mr. _____ to be an excellent young man. He is a grandson of Gen. _____. He is the cousin of C_____ B_____ S_____; related to the H_____ G_____ N_____s, and has an excellent bringing up in every way."

The following reply was received from the firm inquiring:

"Dear Mr. _____: Thank you very much for your letter in regard to Mr. _____. We would say, however, that we do not want the young man for breeding purposes, but for radio work.—Forbes.

Do you know who the Sheik of radio is? Hundreds of letters received by station WDAP have voted their operator, Ralph Shugart, the most captivating and audacious of broadcasting announcers.

New Yorkers looking for diversion during the Christmas holidays should attend the American Radio Exposition at the Grand Central Palace, December 21st to the 30th.

Some two weeks ago a suit was brought into court in Dwight, Ill., by one Edward McWilliams against Wiley Bergman, who operates an amateur spark transmitter. The plaintiff asserts that Bergman spoils the reception of broadcasting. Mr. McWilliams, a wealthy citizen of the downstate town, filed a suit in the circuit court asking that the court define the right of one person over another to occupy the ether with radio messages. He also asks that the court grant an injunction restraining Bergman from operating his sending apparatus when programs are being broadcasted from recognized stations in the United States.

According to the Associated Press dispatch, Mr. McWilliams' action is the first case of the kind ever filed in Illinois and possibly in the United States.

Other fans are eagerly awaiting the outcome of the suit so that they, too, may be guided in procedure against persons sending messages which disturb the pleasure of many more persons who are listening in on prearranged programs from all parts of the country.

Maybe some ham will start a countersuit from some angle.

Operators of the Burndept Company, wireless engineers, heard an hour long radio concert sent out by WJZ, the Newark, N. J., broadcasting station, Sunday night.

Every item on the program was clearly distinguished, including a Chopin overture. This is the first time an American wireless musical program has ever been picked up in Europe.

The Burndept operators also heard messages of nine amateurs. They were 1CMK, Holyoke, Mass.; 1XU, Stockbridge, Mass.; 1AWL, Redbank, N. J.; 9ZY, Danville, Ill.; 8AQO, Cazenovia, Ohio, and 9LG of Jerseyville, Ill.

January, 1923

Amrad Owners--Look!



This Unit is the Amrad R. F. Amplifier

This is the Standard Amrad Set— Note how easily it is hooked up to the Amplifier at the left

New Amrad R. F.

2-Step Amplifier

\$ 40⁰⁰
Complete with Radi-formers

Attach it to your present Amrad Tuner in five minutes. No rewiring. Just string bits of wire across the jumpers and you're all ready to go.

Get distant stations 'way beyond your present range. Bring in signals and concerts clearly even with a short indoor aerial or under static handicaps. Get ten times the pleasure and satisfaction out of your radio set. Owners of sets other than Amrad can also use this Amplifier and get splendid results.



Sixth Floor Consumers Building

Unusual Radio Guarantee

All sets and parts are sold on two weeks' trial. If you are not entirely satisfied, return them and get your money back. The strongest radio guarantee ever written. We are in business to stay and are here to give you a square deal.

CHICAGO FANS—Ask about our new plan for installing and servicing radio sets. The new way in radio insures satisfaction.

Fada—Pacent—and Other Standard Parts

Complete parts of standard, nationally advertised equipment are kept constantly in stock for prompt delivery. Also Amrad and Grebe sets—everything new and up-to-date—the very latest in radio.

We handle only material of established reputation, and every part is sold under our own guarantee.

You can buy radio equipment with the certainty that you are getting the quality you have a right to expect.

Mail order customers receive the same prompt and careful attention as those who buy personally at our Chicago salesrooms. Write us for our new price list.

LYNN RADIO COMPANY

STANDARD NATIONALLY ADVERTISED
RADIO EQUIPMENT

220 South State St. — Chicago, Ill

TELEPHONE HARRISON 7293

JUST OFF THE PRESS

The most up-to-date Treatise on Radio

TEXTBOOK on RADIO

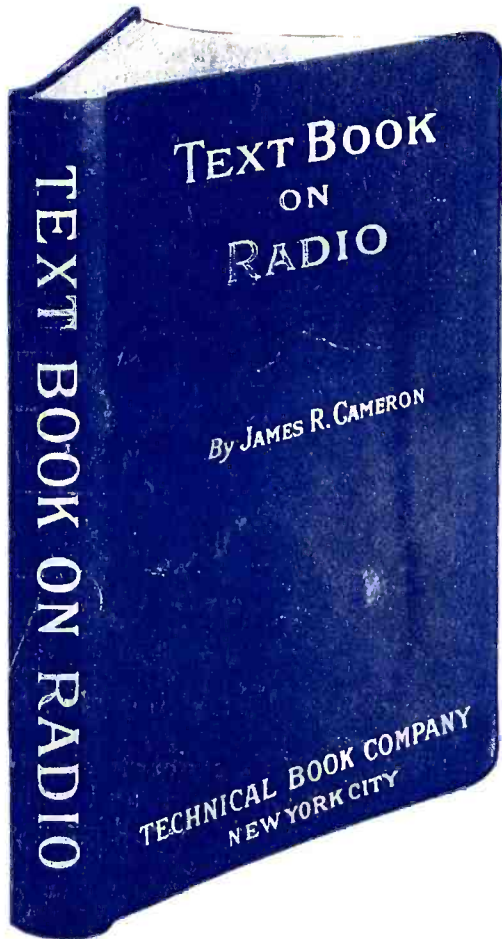

By JAMES R. CAMERON

Whose textbooks are used and indorsed by the U. S. Army, Navy, and Department of Public Instruction

350 Pages. Profusely Illustrated. Written so the amateur can understand it. At the same time—TEXTBOOK ON RADIO—is a standard textbook for the technical radio student.

Order NOW and Be Sure of Your Copy!
Cloth Bound, \$2.50 Flexible Leatho, \$3.00

This new TEXTBOOK on RADIO is the new big brother to Radio's three best sellers

"Radio's Three Best Sellers"



How to Build Your Own Radio Set, 25c

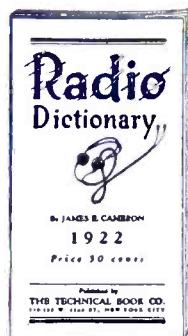

Radio Dictionary, 50c



Radio for Beginners, \$1.00

Buy Them From Your Dealer or Direct From

TECHNICAL BOOK CO.

130 West 42nd Street, Dept. T, New York